

JVC

SERVICE MANUAL

AUDIO/VIDEO CONTROL RECEIVER

RX-7010RBK RX-7012RSL

Area Suffix

E ... Continental Europe
EN Northern Europe

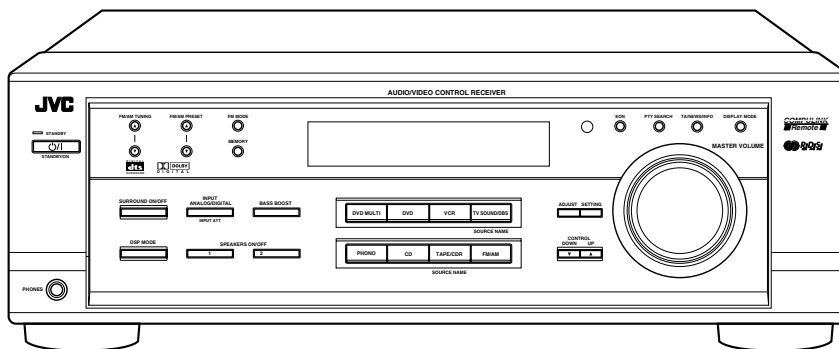
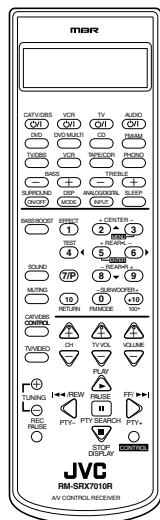

COMPU LINK
Remote

DIGITAL
dts
SURROUND

DOLBY
DIGITAL

Dolby Digital
R/D/S

As for RX-7012RSL the body is silver color

Contents

Safety precautions -----1-2
 Disassembly method -----1-3
 Adjustment method -----1-8
 Description of major ICs -----1-9 ~ 19



Safety Precautions

1. This design of this product contains special hardware and many circuits and components specially for safety purposes. For continued protection, no changes should be made to the original design unless authorized in writing by the manufacturer. Replacement parts must be identical to those used in the original circuits. Services should be performed by qualified personnel only.
2. Alterations of the design or circuitry of the product should not be made. Any design alterations of the product should not be made. Any design alterations or additions will void the manufacturer's warranty and will further relieve the manufacture of responsibility for personal injury or property damage resulting therefrom.
3. Many electrical and mechanical parts in the products have special safety-related characteristics. These characteristics are often not evident from visual inspection nor can the protection afforded by them necessarily be obtained by using replacement components rated for higher voltage, wattage, etc. Replacement parts which have these special safety characteristics are identified in the Parts List of Service Manual. Electrical components having such features are identified by shading on the schematics and by (\triangle) on the Parts List in the Service Manual. The use of a substitute replacement which does not have the same safety characteristics as the recommended replacement parts shown in the Parts List of Service Manual may create shock, fire, or other hazards.
4. The leads in the products are routed and dressed with ties, clamps, tubings, barriers and the like to be separated from live parts, high temperature parts, moving parts and/or sharp edges for the prevention of electric shock and fire hazard. When service is required, the original lead routing and dress should be observed, and it should be confirmed that they have been returned to normal, after re-assembling.

5. Leakage current check (Electrical shock hazard testing)

After re-assembling the product, always perform an isolation check on the exposed metal parts of the product (antenna terminals, knobs, metal cabinet, screw heads, headphone jack, control shafts, etc.) to be sure the product is safe to operate without danger of electrical shock.

Do not use a line isolation transformer during this check.

- Plug the AC line cord directly into the AC outlet. Using a "Leakage Current Tester", measure the leakage current from each exposed metal parts of the cabinet, particularly any exposed metal part having a return path to the chassis, to a known good earth ground. Any leakage current must not exceed 0.5mA AC (r.m.s.).

● Alternate check method

Plug the AC line cord directly into the AC outlet. Use an AC voltmeter having, 1,000 ohms per volt or more sensitivity in the following manner. Connect a 1,500 Ω 10W resistor paralleled by a 0.15 μ F AC-type capacitor between an exposed metal part and a known good earth ground. Measure the AC voltage across the resistor with the AC voltmeter.

Move the resistor connection to each exposed metal part, particularly any exposed metal part having a return path to the chassis, and measure the AC voltage across the resistor. Now, reverse the plug in the AC outlet and repeat each measurement. Any voltage measured must not exceed 0.75 V AC (r.m.s.). This corresponds to 0.5 mA AC (r.m.s.).

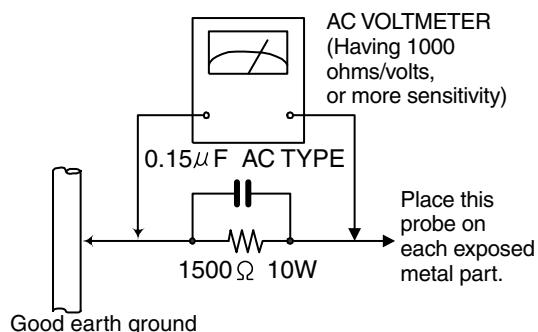

Warning

1. This equipment has been designed and manufactured to meet international safety standards.
2. It is the legal responsibility of the repairer to ensure that these safety standards are maintained.
3. Repairs must be made in accordance with the relevant safety standards.
4. It is essential that safety critical components are replaced by approved parts.
5. If mains voltage selector is provided, check setting for local voltage.

CAUTION

Burrs formed during molding may be left over on some parts of the chassis. Therefore, pay attention to such burrs in the case of preforming repair of this system.

In regard with component parts appearing on the silk-screen printed side (parts side) of the PWB diagrams, the parts that are printed over with black such as the resistor (■), diode (▣) and ICP (●) or identified by the " \triangle " mark nearby are critical for safety.

When replacing them, be sure to use the parts of the same type and rating as specified by the manufacturer. (Except the JC version)

Disassembly method

■ Removing the top cover (See Fig.1)

1. Remove the four screws A attaching the top cover on both sides of the body.
2. Remove the three screws B on the back of the body.
3. Remove the top cover from behind in the direction of the arrow while pulling both sides outward.

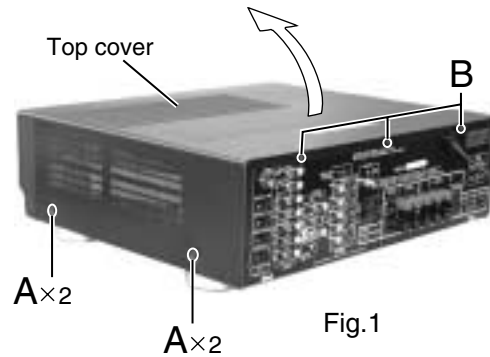

Fig.1

■ Removing the front panel assembly (See Fig.2 and 3)

- Prior to performing the following procedure, remove the top cover.
1. Disconnect the card wire from connector CN402 on the audio board and CN201 on the power supply board in the front panel assembly.
 2. Cut off the tie band fixing the harness.
 3. Remove the three screws C attaching the front panel assembly.
 4. Remove the four screws D attaching the front panel assembly on the bottom of the body. Detach the front panel assembly toward the front.

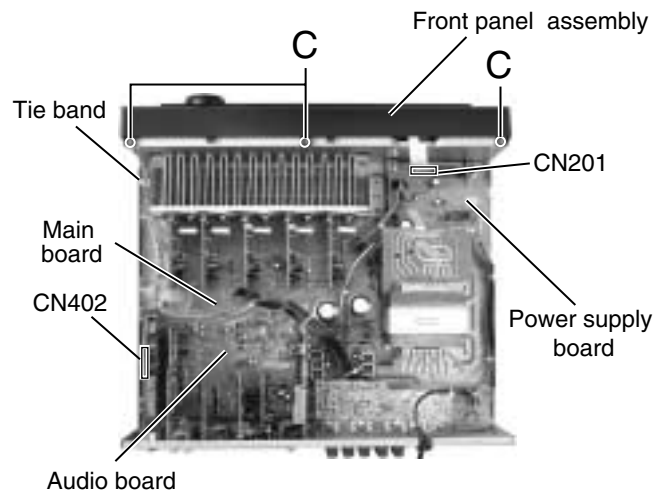

Fig.2

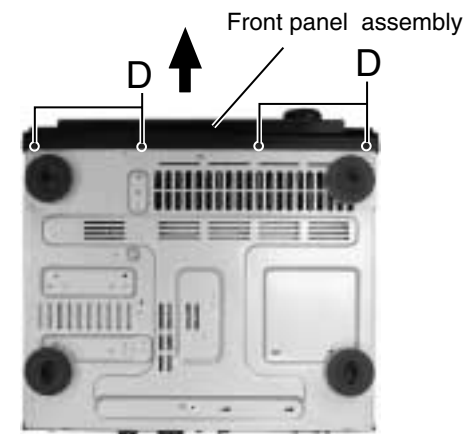

Fig.3

■ Removing the rear panel (See Fig.4)

- Prior to performing the following procedure, remove the top cover.
1. Remove the power cord stopper from the rear panel by moving it in the direction of the arrow.
 2. Remove the twenty seven screws E attaching the each boards to the rear panel on the back of the body.
 3. Remove the four screws F attaching the rear panel on the back of the body.

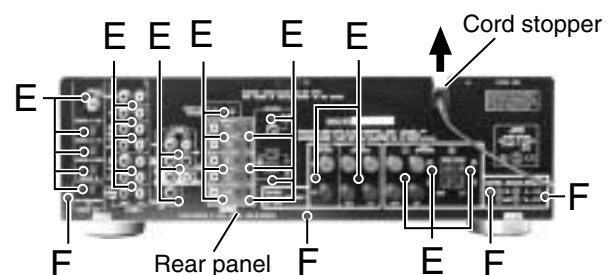

Fig.4

■ Removing each board connected to the rear side of the audio board
(See Fig.5 to 8)

• Prior to performing the following procedure, remove the top cover and the rear panel.

1. Cut off the tie band fixing the harness.
2. Disconnect the DSP board from connector CN481 on the audio board.
3. Disconnect the audio input board, DVD board Video board and the S video board from connector CN421, CN431, CN441 and CN461 on the audio board.
4. Disconnect the tuner board from connector CN411 and CN412 on the audio board.

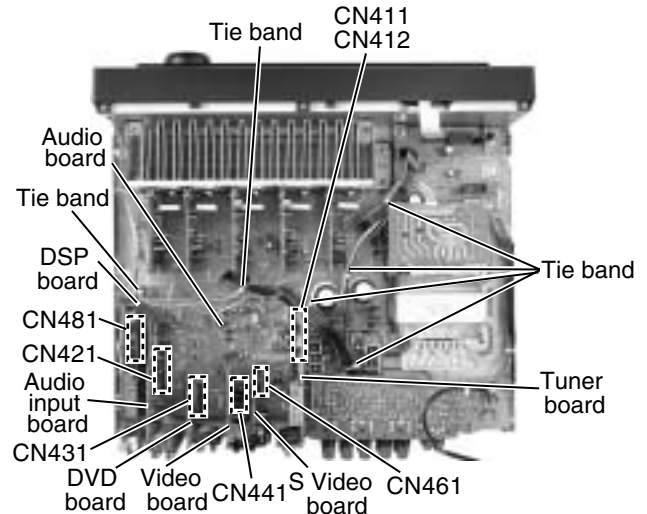

Fig.5

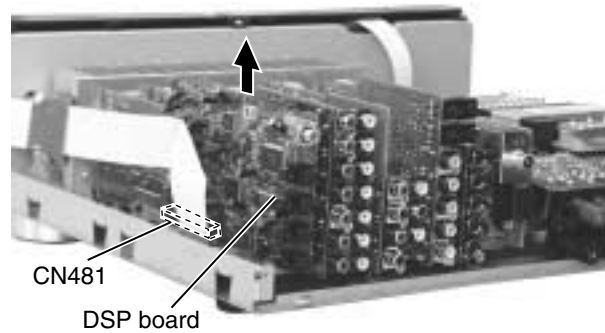

Fig.6

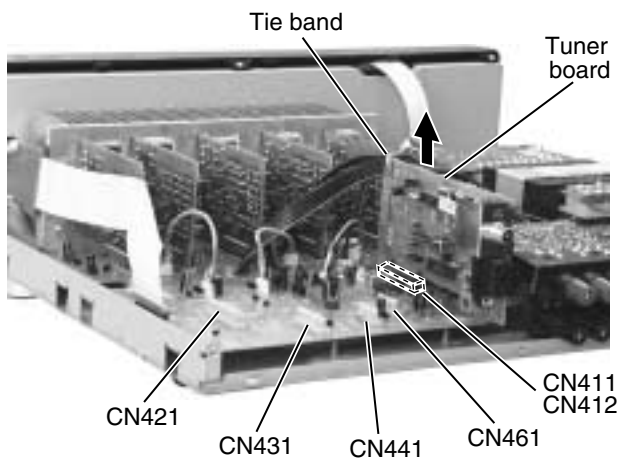

Fig.8

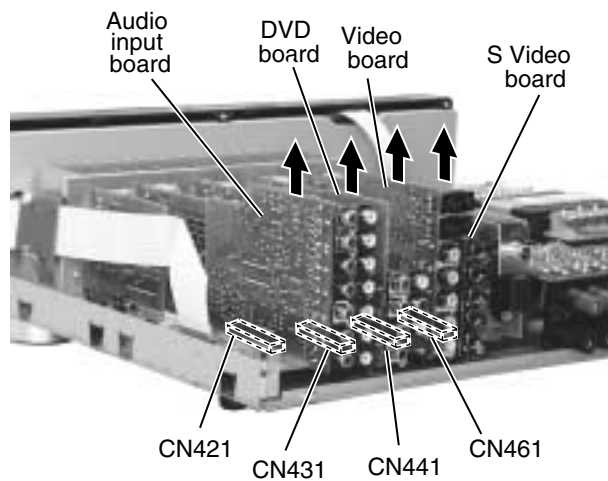

Fig.7

■ Removing the audio board (See Fig.9)

- Prior to performing the following procedure, remove the top cover and the rear panel.
1. Disconnect the card wire from connector CN402 on the audio board.
 2. Disconnect the relay board from the audio board and the power supply board. (CN291,CN491)
 3. Disconnect the harness from connector CN473, CN471, CN472, CN403 and CN385.
 4. Remove the three screws G attaching the audio board assembly.
 5. Remove the screw H attaching the audio board assembly.

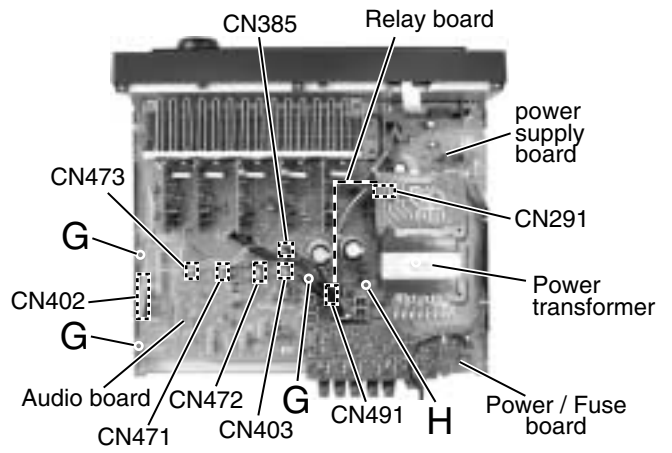

Fig.9

■ Removing the main board (See Fig.10)

- Prior to performing the following procedure, remove the top cover, the rear panel and audio board.
1. Disconnect the harness from connector CN241 and CN203 on the power supply board respectively.
 2. Remove the four screws I and the two screws J attaching the main board.
 3. In case where the sub board is installed, detach it after removing the connectors CN208,CN209 and CN210 as well as the screw J'.

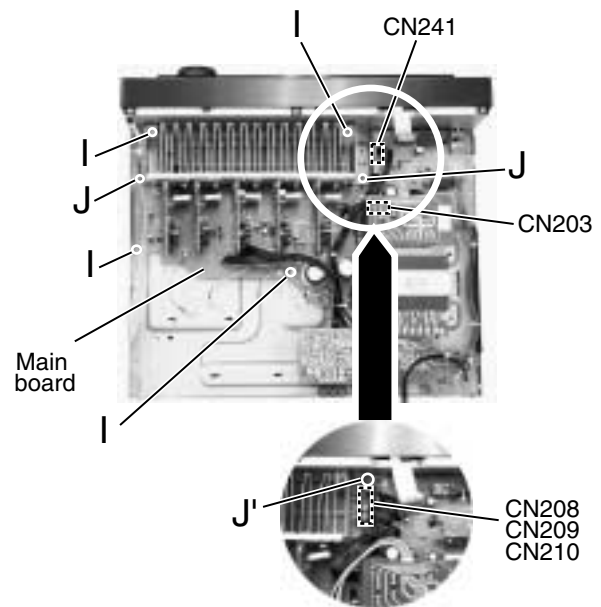

Fig.10

■ Removing the Heat sink (See Fig.11 to 12)

1. Remove the ten screws K and four screws L attaching the heat sink.
2. Remove the two screws L' attaching the heat sink from the rear side of main board.

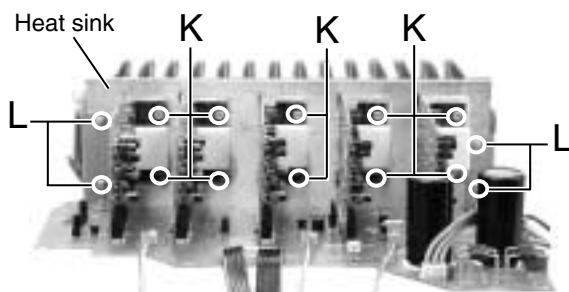

Fig.11

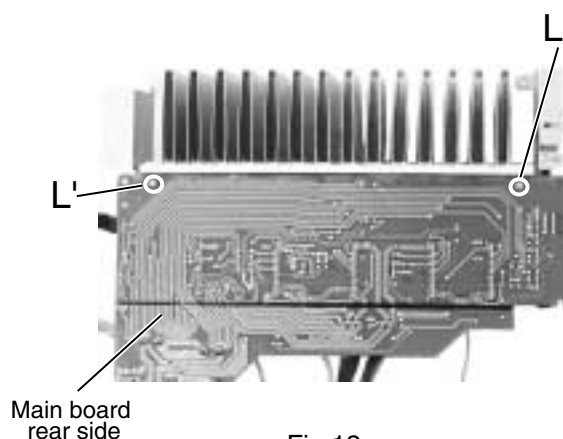

Fig.12

■ Removing the power transformer
(See Fig.13)

- Prior to performing the following procedures, remove the top cover.
1. Unsolder the two harnesses connected to the power transformer.
 2. Disconnect the harness from connector CN251 and unsolder the harnesses connected to FW201 on the power transformer board.
 3. Remove the four screws M attaching the power transformer.

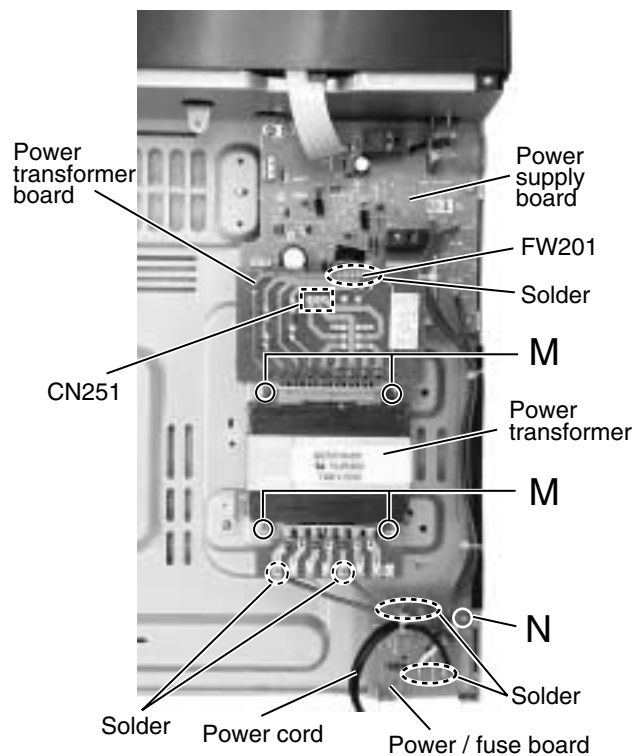

Fig.13

■ Removing the power / fuse board
(See Fig.13)

- Prior to performing the following procedure, remove the top cover and the rear panel.
1. Remove the screw N attaching the power / fuse board.
 2. Unsolder the power cord and other harnesses connected to the power / fuse board.

■ Removing the power supply board
(See Fig.14 and 15)

- Prior to performing the following procedure, remove the top cover and the front panel.
1. Remove the one nut attaching the headphone jack of the power supply board on the front side of the body.
 2. Disconnect the harness connected to connector CN241, CN201, CN203 and CN291 on the power transformer board (If necessary, cut off the band fixing the harness on the side of the base chassis).
 3. Remove the three screws O attaching the power supply board and pull out the power supply board from the front bracket backward.
 4. Unsolder the three harnesses connected to the power supply board.

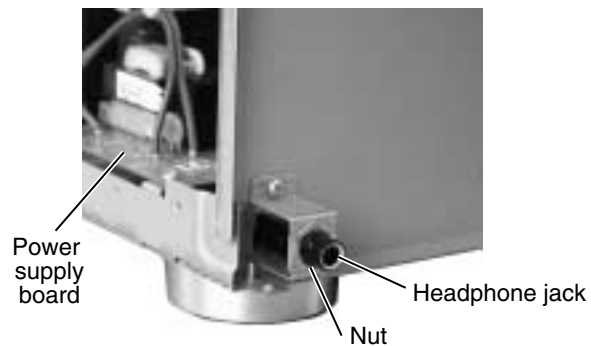

Fig.14

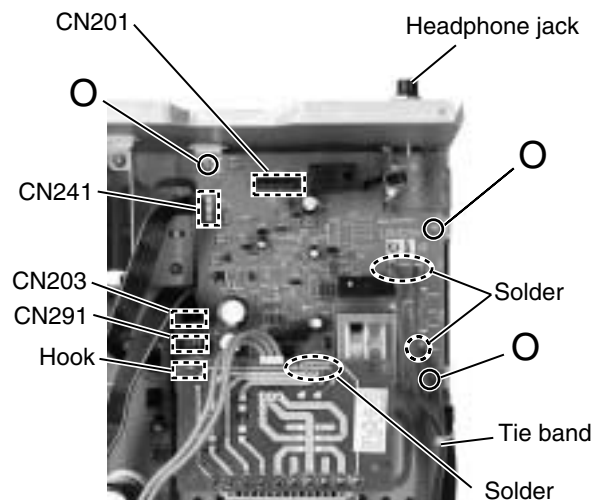

Fig.15

Adjustment method

■ Tuner section

1. Tuner range

FM	87.5MHz~108.0MHz
AM (MW)	522kHz~1629kHz
(LW)	144kHz~ 288kHz

■ Power amplifier section

Adjustment of idling current

Measurement location	TP301(Lch) , TP302(Rch)
Adjustment part	VR301(Lch) , VR302(Rch)

Attention

This adjustment does not obtain a correct adjustment value immediately after the amplifier is used (state that an internal temperature has risen). Please adjust immediately after using the amplifier after turning off the power supply of the amplifier and falling an internal temperature.

<Adjustment method>

1. Set the volume control to minimum during this adjustment. (No signal & No load)
2. Set the surround mode OFF.
2. Turn VR301 and VR302 fully counterclockwise to warm up before adjustment.
If the heat sink is already warm from previous use the correct adjustment can not be made.
3. For L-ch, connect a DC voltmeter between TP301's B216 and B217 (Lch)
And, connect it between TP302's B218 and B219 (Rch).
4. 30 minutes later after power on, adjust VR301 for L-ch, or VR302 for R-ch so that the DC voltmeter value has 1mV~10mV.

* It is not abnormal though the idling current might not become 0mA even if it is finished to turn variable resistance (VR301, VR302) in the direction of counterclockwise.

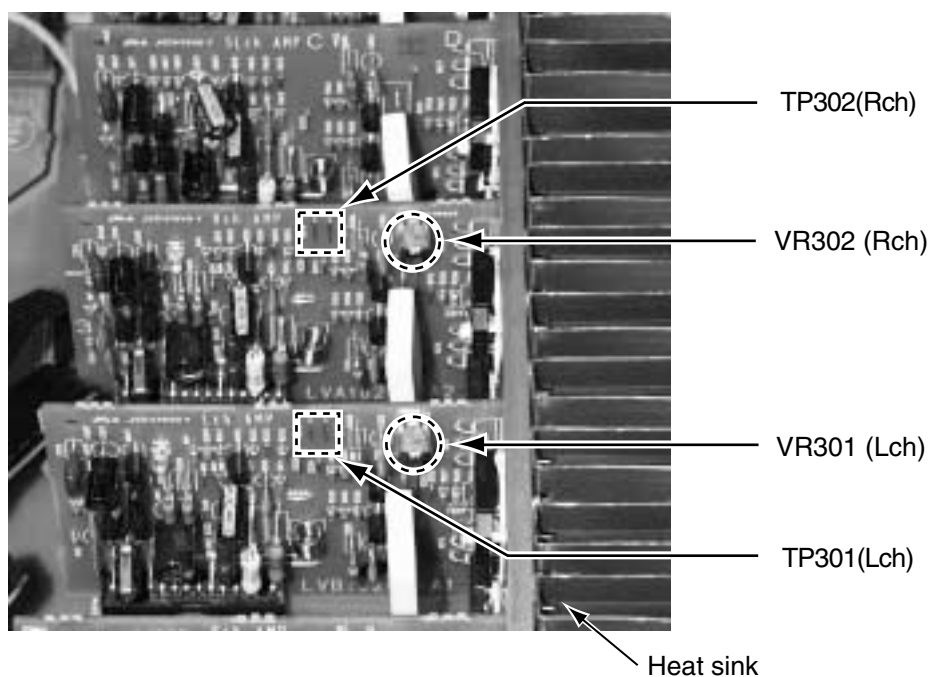

Description of major ICs

■ SAA6588 (IC191) : RDS detector

1. Terminal Layout

MRO	1	20	NC
NC	2	19	CIN
GND	3	18	SCOUT
OSCO	4	17	Vref
OSCI	5	16	MPX
VSSD	6	15	VSSA
VDDD	7	14	VDDA
DAVN	8	13	NC
SDA	9	12	GND
SCL	10	11	NC

2. Pin Function

Pin No.	Symbol	I/O	Function
1	MRO	O	Multi-path rectifier output
2	NC	-	Non connect
3	GND	I	Test control input pin
4	OSCO	O	Oscillator output
5	OSCI	I	Oscillator input
6	VSSD	-	Digital ground (0V)
7	VDDD	-	Digital power supply (5V)
8	DAVN	O	Data available output (active LOW)
9	SDA	I/O	IC-bus serial data I/O
10	SCL	I	IC-bus serial clock input
11	NC	-	Non connect
12	GND	-	Connect to ground
13	NC	-	Non connect
14	VDDA	-	Analog power supply (5V)
15	VSSA	-	Connect to ground
16	MPX	I	Multiplex input signal
17	Vref	O	Reference voltage output
18	SCOUT	O	Band-pass filter output
19	CIN	O	Comparator output
20	NC	I	Level input

3. Block Diagram

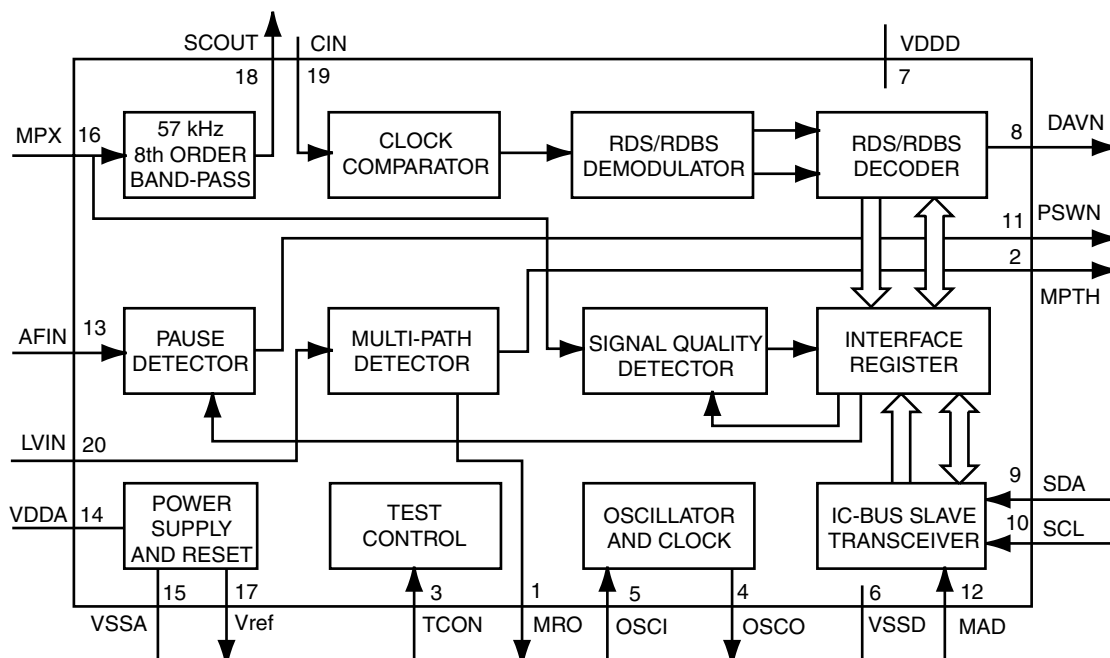

■ AK4527B (IC601) : A/D,D/A converter

1.Pin layout

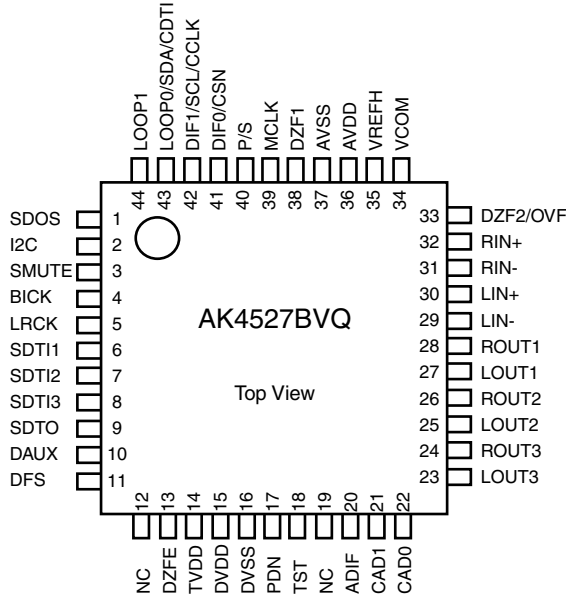

2. Pin function (1/2)

AK4527(1/2)

No.	Pin name	I/O	Function
1	SDOS	I	SDTO Source Select Pin (Note 1) "L" : Internal ADC output, "H" : DAUX input
2	I2C	I	Control Mode Select Pin "L" : 3-wire Serial, "H" : I2C Bus
3	SMUTE	I	Soft Mute Pin (Note 1) When this pin goes to "H", soft mute cycle is initialized. When returning to "L", the output mute releases.
4	BICK	I	Audio Serial Data Clock Pin
5	LRCK	I/O	Input Channel Clock Pin
6	SDTI1	I	DAC1 Audio Serial Data Input Pin
7	SDTI2	I	DAC2 Audio Serial Data Input Pin
8	SDTI3	I	DAC3 Audio Serial Data Input Pin
9	SDTO	O	Audio Serial Data Output Pin
10	DAUX	I	Sub Audio Serial Data Input Pin
11	DFS	I	Double Speed Sampling Mode Pin (Note 1) "L" : Normal Speed, "H" : Double Speed
12	NC	-	No Connect No internal bonding.
13	DZEF	I	Zero Input Detect Enable Pin "L" : mode 7 (disable) at parallel mode, zero detect mode is selectable by DZFM2-0 bits at serial mode. "H" : mode 0 (DZF is AND of all six channels)
14	TVDD	-	Output Buffer Power supply Pin, 2.7V~5.5V
15	DVDD	-	Digital Power Supply Pin, 4.5V~5.5V
16	DVSS	-	De-emphasis Pin, 0V
17	PDN	I	Power-Down & Reset Pin When "L", the AK4527B is powered-down and the control registers are reset to default state. If the state of P/S or CAD0-1 changes, then the AK4527B must be reset by PDN.
18	TST	I	Test Pin This pin should be connected to DVSS.

Pin function (2/2)

AK4527(1/2)

No.	Pin name	I/O	Function
19	NC	-	No Connect No internal bonding.
20	ADIF	I	Analog Input Format Select Pin "H" : Full-differential input, "L" : Single-ended input
21	CAD1	I	Chip Address 1 Pin
22	CAD0	I	Chip Address 0 Pin
23	LOUT3	O	DAC3 Lch Analog Output Pin
24	ROUT3	O	DAC3 Rch Analog Output Pin
25	LOUT2	O	DAC2 Lch Analog Output Pin
26	ROUT2	O	DAC2 Rch Analog Output Pin
27	LOUT1	O	DAC1 Lch Analog Output Pin
28	ROUT1	O	DAC1 Rch Analog Output Pin
29	LIN-	I	Lch Analog Negative Input Pin
30	LIN+	I	Lch Analog Positive Input Pin
31	RIN-	I	Rch Analog Negative Input Pin
32	RIN+	I	Rch Analog Positive Input Pin
33	DZF2	O	Zero Input Detect 2 Pin (Note 2) When the input data of the group 1 follow total 8192LRCK cycles with "0" input data, this pin goes to "H".
	OVF	O	Analog Input Overflow Detect Pin (Note 3) This pin goes to "H" if the analog input of Lch or Rch is overflows.
34	VCOM	O	Common Voltage Output Pin, AVDD/2 Large external capacitor around 2.2uF is used to reduce power-supply noise.
35	VREFH	I	Positive Voltage Reference Input Pin, AVDD
36	AVDD	-	Analog Power Supply Pin, 4.5V~5.5V
37	AVSS	-	Analog Ground Pin, 0V
38	DZF1	O	Zero Input Detect 1 Pin (Note 2) When the input data of the group 1 follow total 8192 LRCK cycles with "0" input data, this pin goes to "H".
39	MCLK	I	Master Clock Input Pin
40	P/S	I	Parallel / Serial Select Pin "L" : Serial control mode, "H" : Parallel control mode
41	DIF0	I	Audio Data Interface Format 0 Pin in parallel mode
	CSN	I	Chip select pin in 3-wire serial control mode This pin should be connected to DVDD at I2C bus control mode
42	DIF1	I	Audio Data Interface Format 1 Pin in parallel mode
	SCL/CCLK	I	Control Data Clock Pin in serial control mode I2C = "L" : CCLK(3-wire Serial), I2C = "H" : SCL(I2C Bus)
43	LOOP0	I	Loopback Mode 0 Pin in parallel control mode Enables digital loop-back from ADC to 3 DACs.
	SAD/CDTI	I/O	Control Data Input Pin in serial control mode I2C = "L" : CDTI(3-wire Serial), I2C = "H" : SDA(I2C Bus)
44	LOOP1	I	Loopback Mode 1 Pin (Note 1) Enable all 3 DAC channels to be input from SDTI.

- Notes : 1. SDOS, SMUTE, DFS, and LOOP1 pins are ORed with register data if P/S = "L".
2. The group 1 and 2 can be selected by DZFM2-0 bit if P/S = "L" and DZFM2 = "L".
3. This pin becomes OVF pin if OVFE bit is set to "1" at serial control mode.
4. All input pins should not be left floating.

TC9164AN (IC402) : Analog switch

1.Function

Switch to On/Off of S1 to S8 by control of LSI.

2.Terminal Lay out & Block Diagram

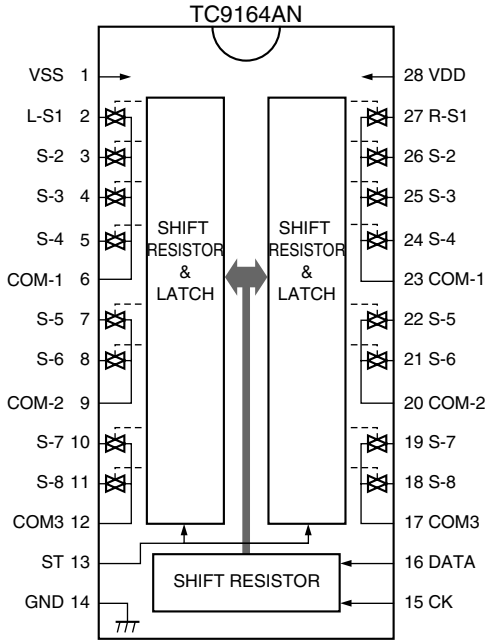

NJM2246D (IC501,IC551,IC552) : Video switch

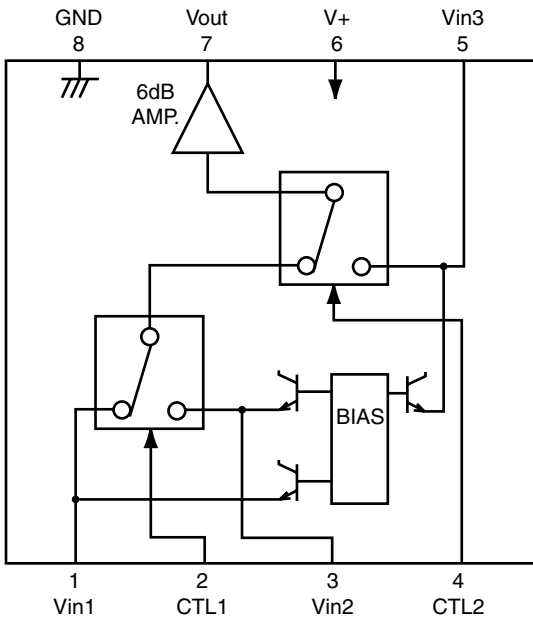

Control input - output signal

CTL 1	CTL 2	Output
L	L	VIN 1
H	L	VIN 2
L/H	H	VIN 3

■ **W24L010AJ-12 (IC641) : CMOS SRAM**

Block diagram

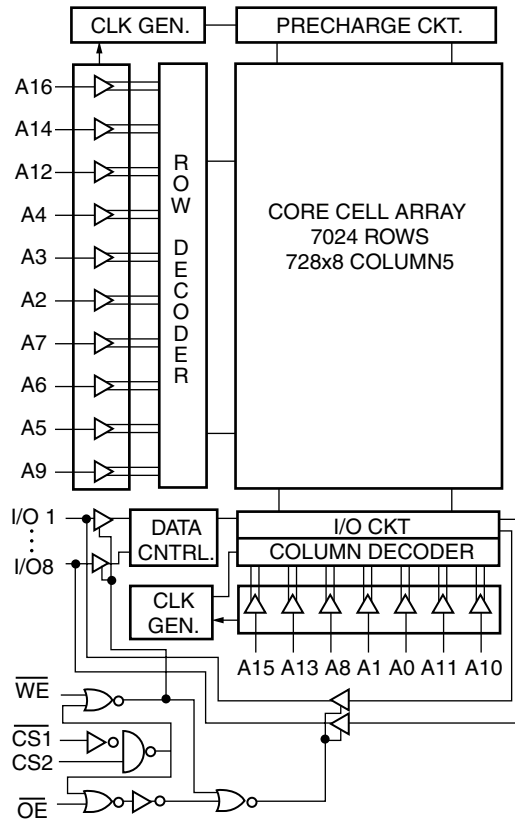

Pin layout

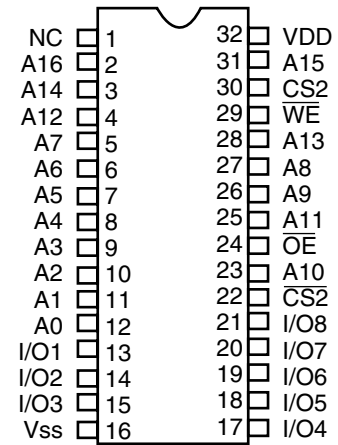

■ **PQ3DZ53 (IC681) : Regulator IC**

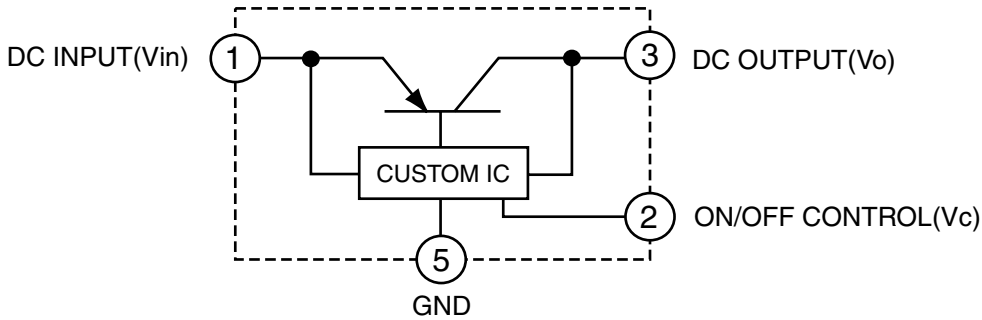

■ **RN5RZ33BA (IC683) : Voltage regulator**

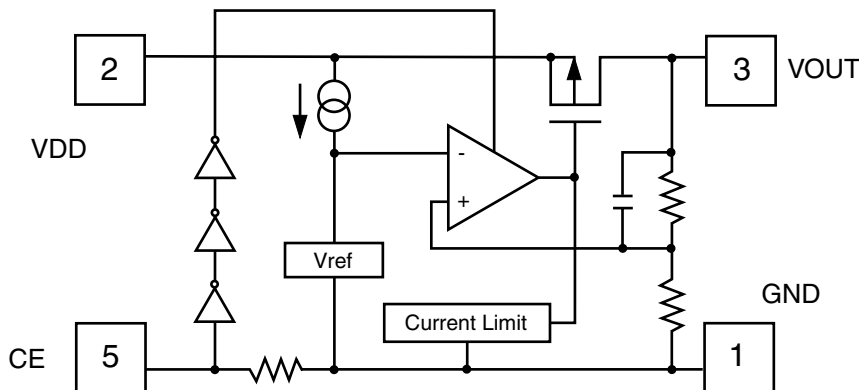

■ M62446FP (IC428) : 6CH master volume

1. Block Diagram

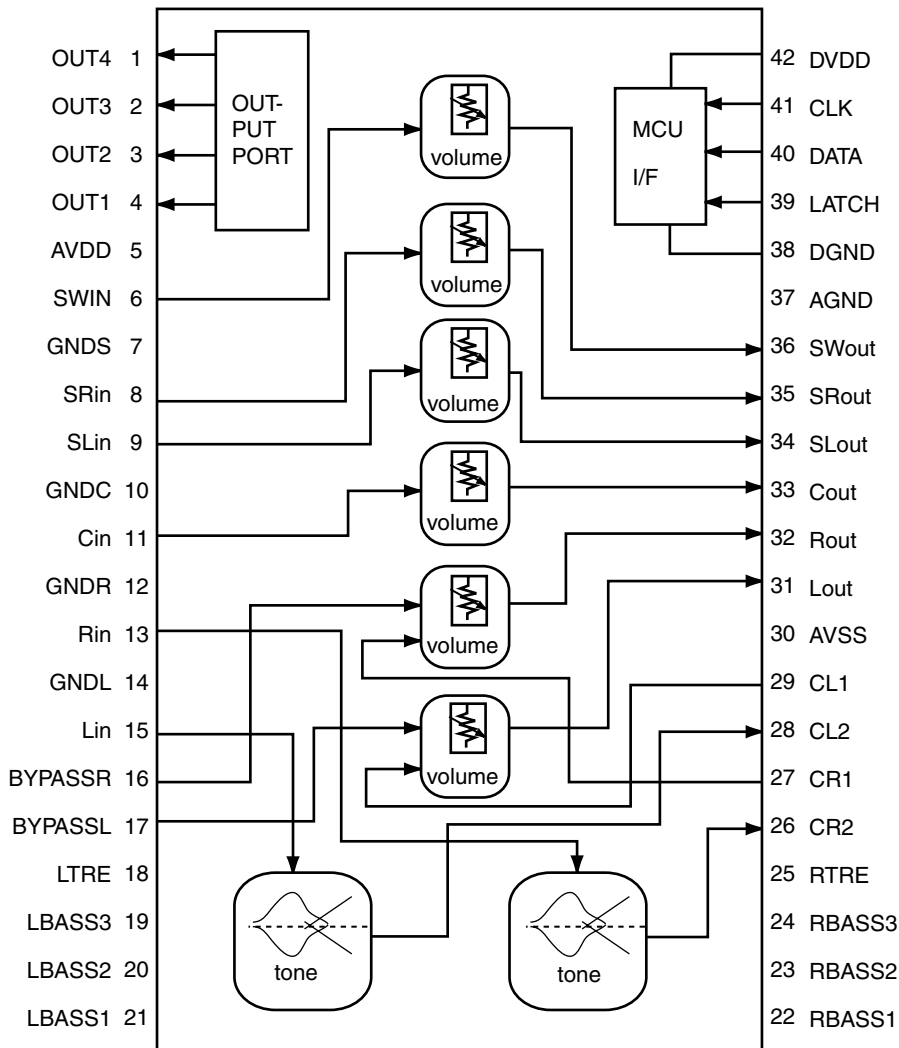

2.Pin Function

Pin No.	Symbol	I/O	Descriptions
1	SURROUND	O	SURROUND control terminal
2	BASS BOOST	O	BASS BOOST control terminal
3	INPUT-ATT	O	Input attenuator control terminal
4	MUTING	O	MUTING control terminal
5	AVDD	-	Analog positive power supply terminal
6	SWIN	I	SUB Woofer volume signal input terminal
7	A.GND	-	Analog ground terminal
8	RR IN	I	R ch volume signal input terminal for rear speaker
9	RL IN	I	L ch volume signal input terminal for rear speaker
10	A.GND	-	Analog ground terminal
11	C IN	I	Center volume signal input terminal
12	A.GND	-	Analog ground terminal
13	R IN	I	R ch volume signal input terminal
14	A.GND	-	Analog ground terminal
15	L IN	I	L ch volume signal input terminal
16,17	BYPASSR,L	-	Non connect
18	LTRE	-	Frequency adjustment terminal tone/treble
19~21	LBASS3~1	-	Frequency adjustment terminal tone/bass
22	CR2	O	Tone output terminal
23,24	RBASS2,4	-	Frequency adjustment terminal tone/bass
25	RTRE	-	Frequency adjustment terminal tone/treble
26	RBASS1	-	Frequency adjustment terminal tone/bass
27	CR1	I	L/R volume input terminal
28	CL2	O	Tone output terminal
29	CL1	I	L/R volume input terminal
30	AVSS	-	Analog negative power supply terminal
31	L OUT	O	L ch output
32	R OUT	O	R ch output
33	C OUT	O	Center volume signal output terminal
34	RL OUT	O	L ch volume signal output terminal for rear speaker
35	RR OUT	O	R ch volume signal output terminal for rear speaker
36	SW OUT	O	SUB Woofer volume signal output terminal
37	A.GND	-	Analog ground terminal
38	D.GND	-	Digital ground terminal
39	VOL STB	I	Latch input terminal
40	VOL DATA	I	Volume data input terminal
41	VOL CLK	I	Clock input terminal for data transfer
42	DVDD	-	Digital power supply terminal

■MN101C35DHK1 (IC701) : System controller

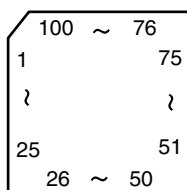

Pin function (1/2)

Pin No.	Symbol	I/O	Function
1	TXD/SB00/P00	I	VOL.JOG IN_1
2	RXD/SBI0/P01	I	VOL.JOG IN_2
3	SBT0/P02	I/O	DATA (PLL)
4	SB01/P03	O	CLK (PLL)
5	SBI1/P04	O	CE (PLL)
6	SBT1/P05	I	VIDEO S/C DVD
7	BUZZER/P06	I	VIDEO S/C VCR
8	VDD	-	Power supply +5V
9,10	OSC1,2	I/O	OSC (8MHz)
11	VSS	-	GND
12	XI	I	GND
13	X0	O	OPEN
14	MMOD	I	GND
15	VREF-	-	GND
16	AN0/PA0	I	KEY INPUT 1 (7KEY)
17	AN1/PA1	I	KEY INPUT 2 (7KEY)
18	AN2/PA2	I	KEY INPUT 3 (7KEY)
19	AN3/PA3	I	KEY INPUT 4 (7KEY)
20	AN4/PA4	I	KEY INPUT 5 (7KEY)
21	AN5/PA5	I	INH IN
22	AN5/PA5	I	CHIP SELECT 1
23	AN5/PA5	I	CHIP SELECT 2
24	VREF+	-	Power supply +5V
25	P07	I	VIDEO S/C DBS
26	RST /P27	I	RESET INPUT
27	RNOUT/TM0I0/P10	O	RDS CLK OUT (RDS)
28	TM1I0/P11	I	DCS INPUT
29	TM2I0/P12	O	DCS OUTPUT
30	TM3I0/P13	I	AVLINK VCR IN
31	TM4I0/P14	O	AVLINK VCR OUT
32	P15	I/O	RDS DATA (RDS)
33	IRQ0/P20	I	PROTECTOR IN
34	SENS/IRQ1/P21	I	REMOCON INPUT
35	IRQ2/P22	I	TUNED IN (TUNER)
36	IRQ3/P23	I	STEREO IN (TUNER)
37	IRQ4/P24	I	RDS DAVN (RDS)
38	P25	I	SELF CHECK INPUT
39	SB02/P30	O	COMMAND (DSP)
40	SBI2/P31	I	STATUS (DSP)

Pin function (2/2)

Pin No.	Symbol	I/O	Function
41	SBT2/P32	O	CLK (DSP)
42	P50	O	READY (DSP)
43	P51	O	RESET (DSP)
44	P52	O	RELAY S
45	P53	O	RELAY C
46	P54	O	RELAY L/R 1
47	DGT17/P67	O	RELAY L/R 2
48	DGT16/P66	O	RELAY HEADPHONE
49~64	G16~G1	O	FL GRID SIGNAL CONTROL OUT
65~80	P87~P90	O	FL SEGMENT SIGNAL CONTROL OUT
81	SEG24/PC2	-	No Connect
82	SEG25/PC1	-	No Connect
83	SEG26/PC0	-	No Connect
84	SEG27/PB7	-	No Connect
85	SEG28/PB6	-	No Connect
86	SEG29/PB5	-	No Connect
87	SEG30/PB4	-	No Connect
88	SEG31/PB3	-	No Connect
89	SEG32/PB2	O	SOUSE MUTE
90	SEG33/PB1	O	SUBWOOFER MUTE
91	SEG34/PB0	O	TUNER MUTE
92	SEG35/PD7	O	POWER ON (STANDBY)
93	SEG36/PD6	O	SURROUND
94	SEG37/PD5	O	DATA (A.SW)
95	SEG38/PD4	O	CLK (A.SW)
96	SEG39/PD3	O	STB (A.SW)
97	SEG40/PD2	O	LATCH (VOL)
98	SEG41/PD1	O	DATA (VOL)
99	SEG42/PD0	O	CLK (VOL)
100	VPP	O	VPP

**■ TC9446F-014 (IC631) : Digital signal processor for dolby digital (AC-3)
/ MPEG2 audio decode**

Pin No.	Symbol	I/O	Function
1	RST	I	Reset signal input terminal (L:reset H:Operation usually)
2	MIMD	I	Microcomputer interface mode selection input terminal (L:serial H:IC bus)
3	MICS	I	Microcomputer interface chip select input terminal
4	MILP	I	Microcomputer interface latch pulse input
5	MIDIO	I/O	Microcomputer interface data I/O terminal
6	MICK	I	Microcomputer interface clock input terminal
7	MIACK	O	Microcomputer interface acknowledge output terminal
8~11	FI0~3	I	Flag input terminal 0~3
12	IRQ	I	Interrupt input terminal
13	VSS	-	Digital ground terminal
14	LRCKA	I	Audio interface LR clock input terminal A
15	BCKA	I	Audio interface bit clock input terminal A
16~18	SDO0~2	O	Audio interface data output terminal 0
19	SD03	-	Non connect
20	LRCKB	I	Audio interface LR clock input terminal B
21	BCKB	I	Audio interface bit clock input terminal B
22	SDT0	I	Audio interface data input terminal 0
23	SDT1	I	Audio interface data input terminal 1
24	VDD	-	Power supply for digital circuit
25	LRCKOA	O	Audio interface LR clock output terminal A
26	BCKOA	O	Audio interface bit clock output terminal A
27,28	TEST0,1	I	Test input terminal 0/1 (L:test H:operation usually)
29~31	LRCKOB,BCKOB,TXO	-	Non connect
32,33	TEST2,3	I	Test input terminal (L:test H:operation usually)
34	RX	I	SPDIF input terminal
35	VSS	-	Ground terminal for digital circuit
36	TSTSUB0	I	Test sub input terminal 0 (L:test H:operation usually)
37	FCONT	O	VCO Frequency control output terminal
38,39	TSTSUB1,TSTSUB2	I	Test sub input terminal 1,2 (L:test H:operation usually)
40	PDO	O	Phase error signal output terminal
41	VDDA	-	Power supply for analog circuit
42	PLON	I	Clock selection input terminal (L:external clock H:VCO clock)
43	AMPI	I	AMP.input terminal for LPF
44	AMPO	O	AMP.output terminal for LPF
45	CKI	I	External clock input terminal
46	VSSA	-	Ground terminal for analog circuit
47	CKO	O	DIR Clock output terminal
48	LOCK	O	VCO Lock detection output terminal
49	VSS	-	Ground terminal for digital circuit
50	WR	O	External SRAM writing signal output terminal
51	OE	O	External SRAM output enable signal output terminal
52	CE	O	External SRAM chip enable signal output terminal
53	VDD	-	Power supply terminal for digital circuit
54~61	IO7~0	I/O	External SRAM data I/O terminal 7~0
62	VSS	-	Ground terminal for digital circuit
63~70	AD0~7	O	External SRAM address output terminal 0~7
71	VDD	-	Power supply terminal for digital circuit
72~80	AD8~16	O	External SRAM address output terminal 8~16
81	VSS	-	Ground terminal for digital circuit
82~89	PO0~7	O	General purpose output terminal 0~7
90	VDDDL	-	Power supply terminal for DLL
91	LPFO	O	LPF output terminal for DLL
92,93	DLON,DLCKS	I	Refer to the undermentioned table
94	SCKO	-	Non connect
95	VSSDL	-	Ground terminal for DLL
96	SCKI	I	External system clock input terminal
97	VSSX	-	Ground terminal for oscillation circuit
98,99	XO,XI	I/O	Oscillation I/O terminal
100	VDDX	-	Power supply terminal for oscillation circuit

DLCKS terminal	DLONterminal	DLL clock setting
L	L	SCKI input (DLL circuit OFF)
L	H	Four times XI clock
H	L	Three times XI clock
H	H	Six times XI clock

■ UPD784215AGC103 (IC671) : UNIT CPU

1.Pin layout

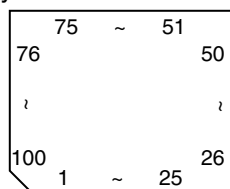

2.Pin function

Pin No.	Symbol	I/O	Function
1~8		-	Non connect
9	VDD	-	Power supply terminal
10	X2	O	Connecting the crystal oscillator for system main clock
11	X1	I	Connecting the crystal oscillator for system main clock
12	VSS	-	Connect to GND
13	XT2	O	Connecting the crystal oscillator for system sub clock
14	XT1	I	Connecting the crystal oscillator for system sub clock
15	RESET	I	System reset signal input
16	AUTODATA	I	Output of DSP to general-purpose port
17	LOCK	I	Output of DSP to general-purpose port
18	DIGITAL0	I	Output of DSP to general-purpose port
19	FORMAT	I	Output of DSP to general-purpose port
20	CHANNEL	I	Output of DSP to general-purpose port
21	ERR	I	Output of DSP to general-purpose port
22	RSTDET	I	Reset signal input
23	AVDD	-	Power supply terminal
24	AVREF0	-	Connect to GND
25~32		-	Connect to GND
33	AVSS	-	Connect to GND
34,35		-	Non connect
36	AV REF1	-	Power supply terminal
37,38	RX,TX	-	Not use
39		-	Non connect
40	DSPCOM	I	Communication port from IC701
41	DSPSTS	O	Status communication port to IC701
42	DSPCLK	I	Clock input from IC701
43	DSPRDY	I	Ready signal input from IC701
44		-	Non connect
45,46	MIDIO_IN/OUT	I/O	Interface I/O terminal with microcomputer
47	MICK	O	Interface I/O terminal with microcomputer of clock signal
48	MICS	O	Interface I/O terminal with microcomputer of chip select
49	MILP	O	Interface I/O terminal with microcomputer
50	MIACK	O	Interface I/O terminal with microcomputer
51,52		-	Non connect
53	DSPRST	O	Reset signal output of DSP
54~63		-	Non connect
64,65	CDTI/CDTO	I/O	Interface I/O terminal with microcomputer
66	CCLK	O	Interface I/O terminal with microcomputer of clock signal
67	CS	O	Interface I/O terminal with microcomputer of chip select
68	XTS	O	OSC Select
69,70		-	Non connect
71	PD	O	Reset signal output
72	GND	-	Connect to GND
73~80		-	Non connect
81	VDD	-	Power supply
82	3D-ON	-	Non connect
83	3D-ON	O	Switch at output destination of surround channel
84	ANA/T-TONE	O	Test tone control
85	REF-MIX	O	Control at output destination of LFE channel
86		-	Non connect
87	D.MUTE	O	Mute of the digital out terminal is controlled
88	S.MUTE	O	Mute of the audio signal is controlled
89		-	Non connect
90~93	ASW1~4	O	Selection of digital input selector
94	TEST	-	Test terminal
95~100		-	Non connect

Block diagram

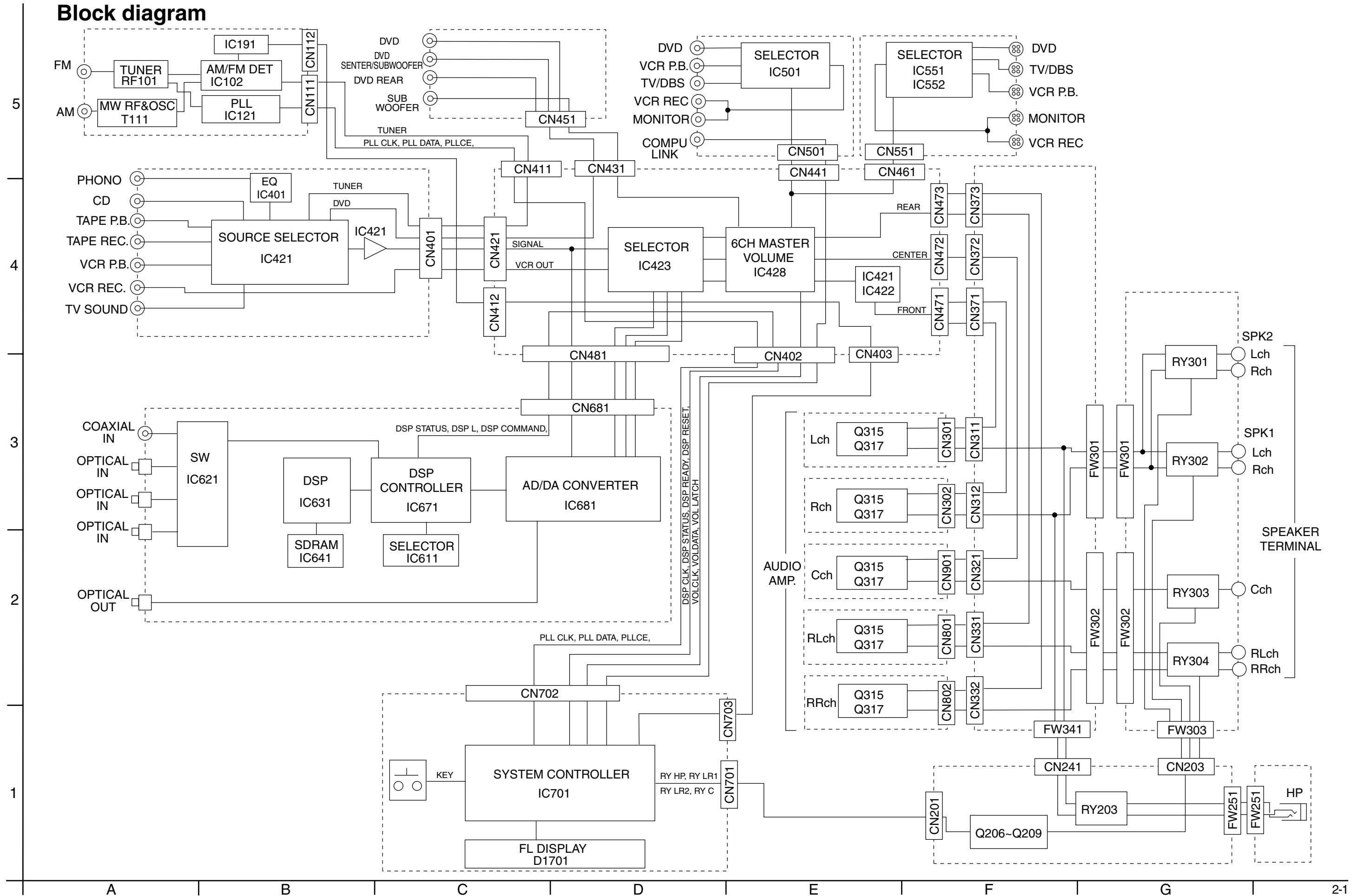

Standard schematic diagrams

Power supply section

5

4

3

2

1

B/E/EN

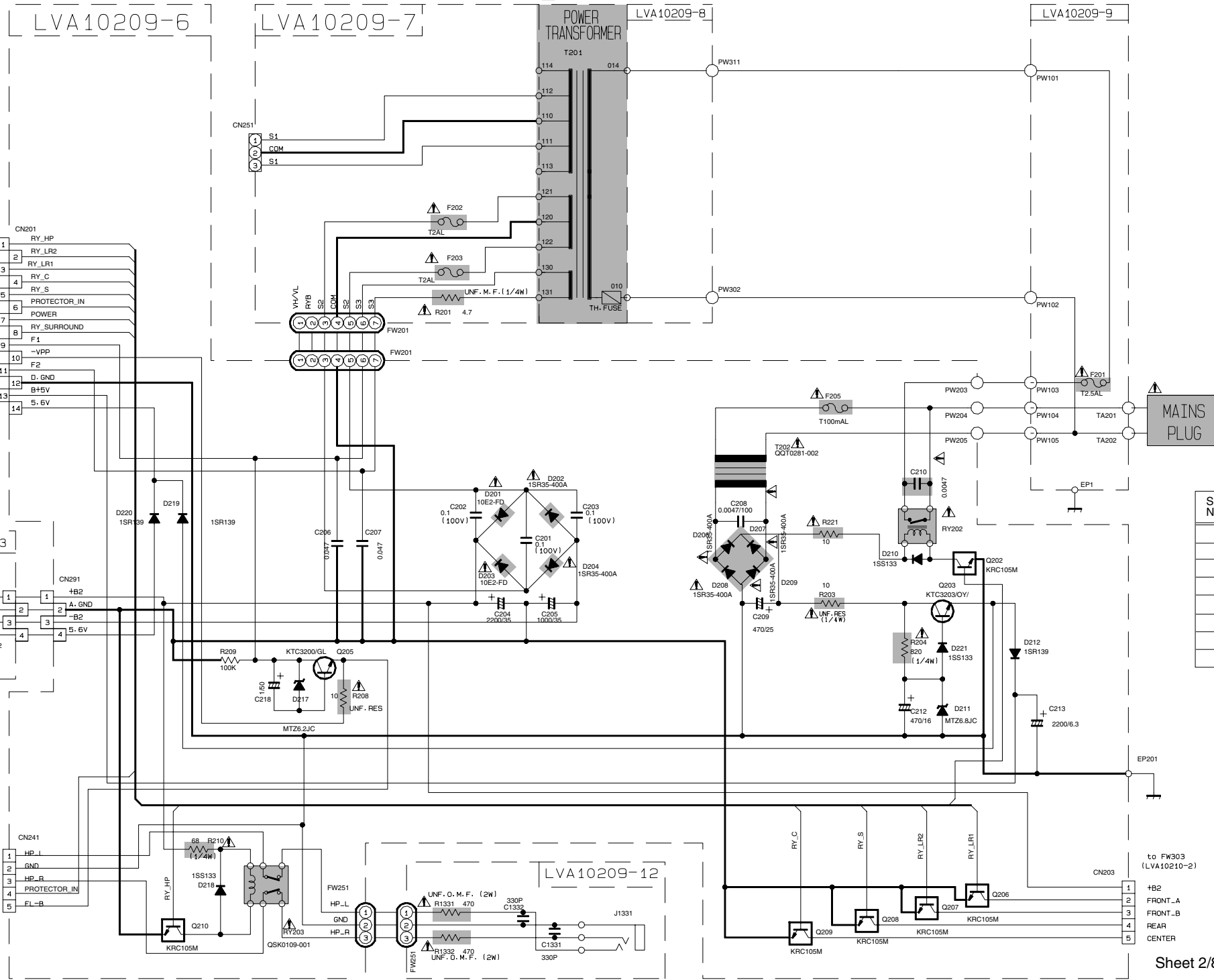

SHEET NUMBER	CIRCUIT DESCRIPTION
1 / 8	POWER SUPPLY
2 / 8	SPEAKER TERMINAL
3 / 8	AUDIO AMP
4 / 8	VOLUME / REGULATOR / SOURCE SELECT IC
5 / 8	AUDIO VIDEO SIGNAL INPUT TERMINAL
6 / 8	SURROUND IC / DIGITAL SIGNAL INPUT TERMINAL
7 / 8	USER CONTROL KEY / SYSTEM CONTROL LSI / FL DISPLAY
8 / 8	TUNER

Parts are safety assurance parts. When replacing those parts make sure to use the specified.

Sheet 7/8

Sheet 2/8

Sheet 2/8

■ Audio & Speaker terminal section

Sheet 1/8

LVA10210-1

FW485
(LVA10211-1)
Sheet 4/8

LVA10210-2

Sheet 1/8





Sheet 1/8

Sheet 3/8

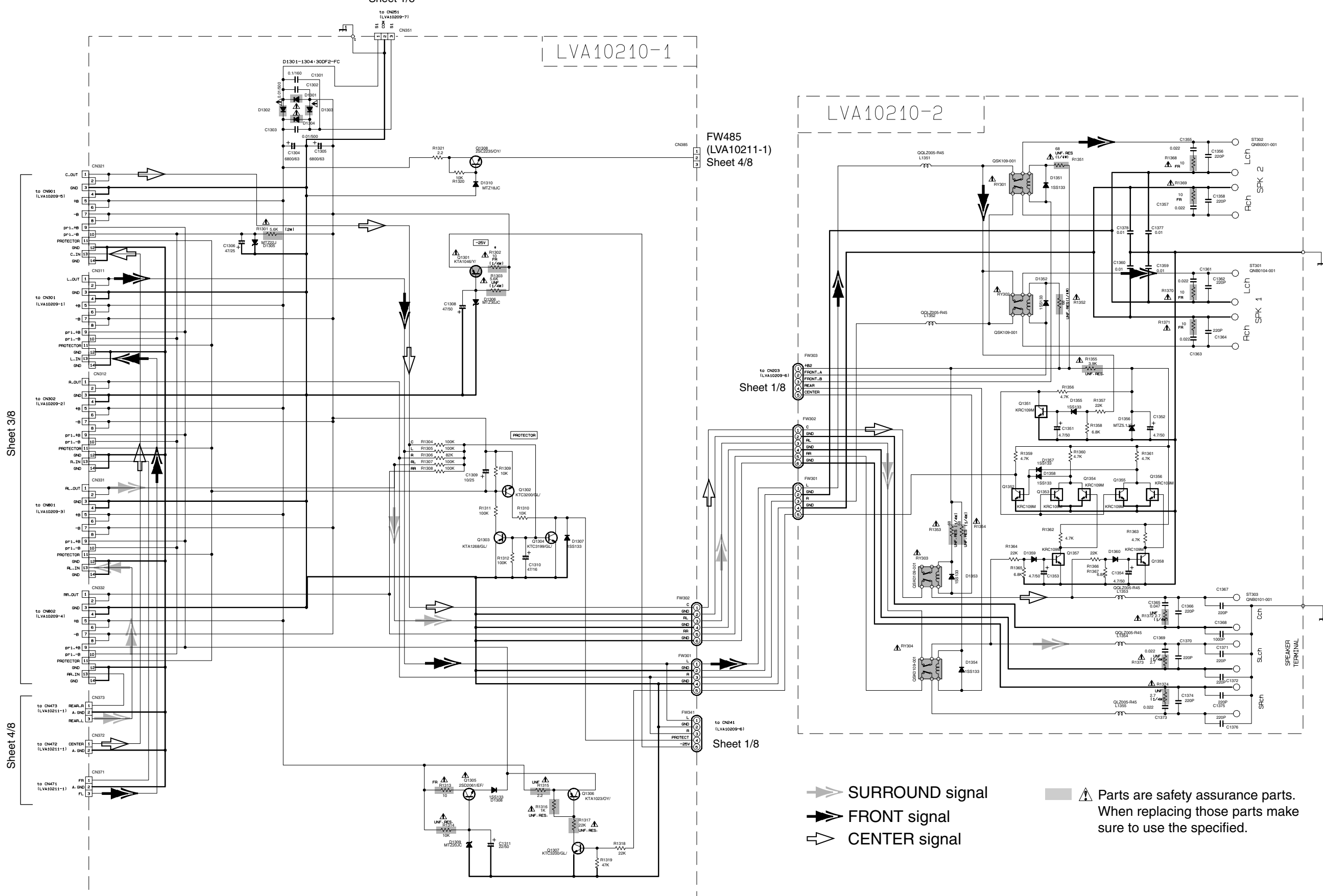
Sheet 4/8

5
4
3
2
1



-  SURROUND signal
-  FRONT signal
-  CENTER signal
-  Parts are safety assurance parts. When replacing those parts make sure to use the specified.

Audio amplifier section

5

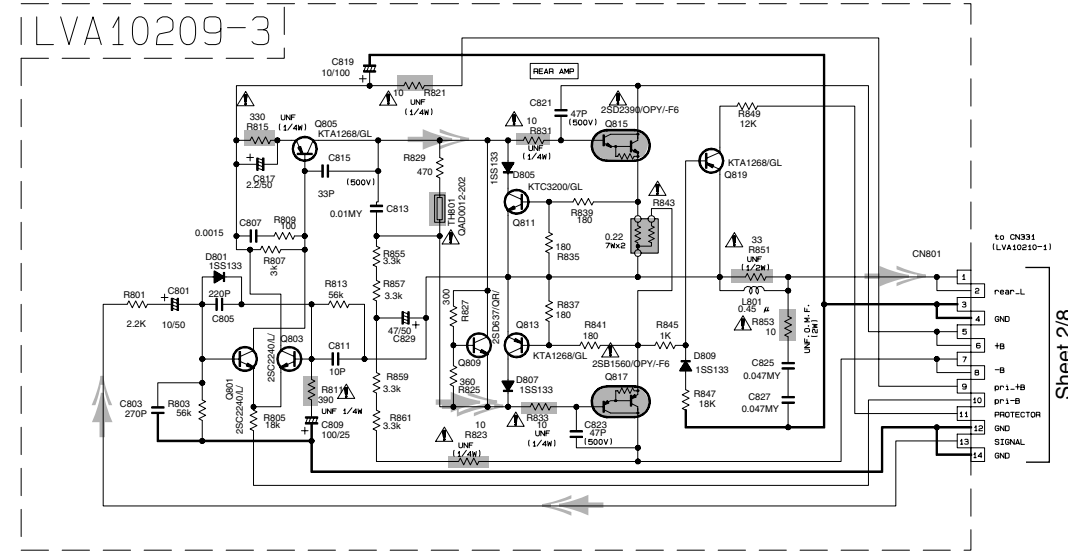
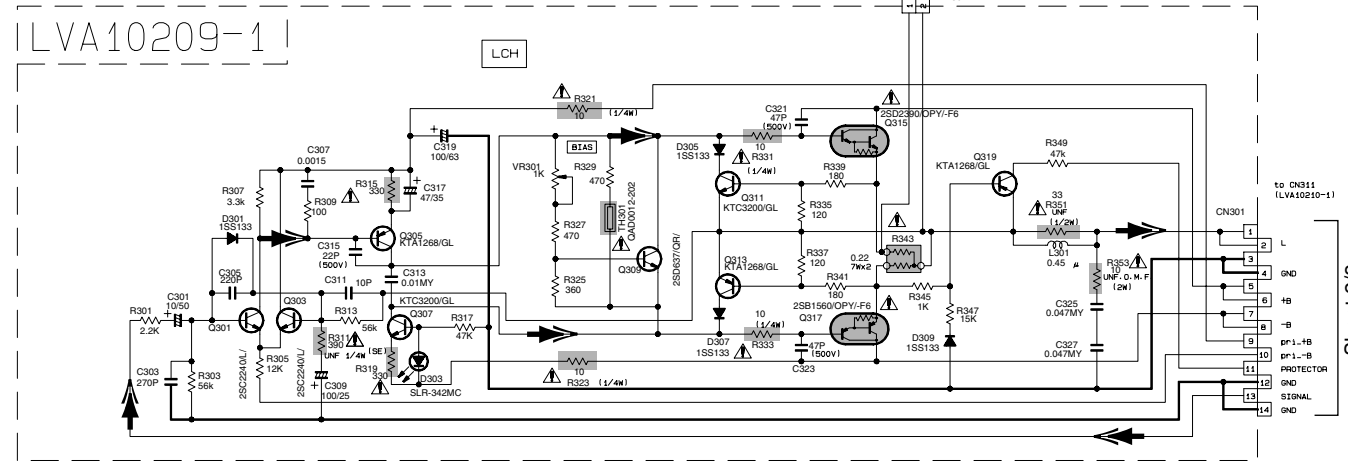

4

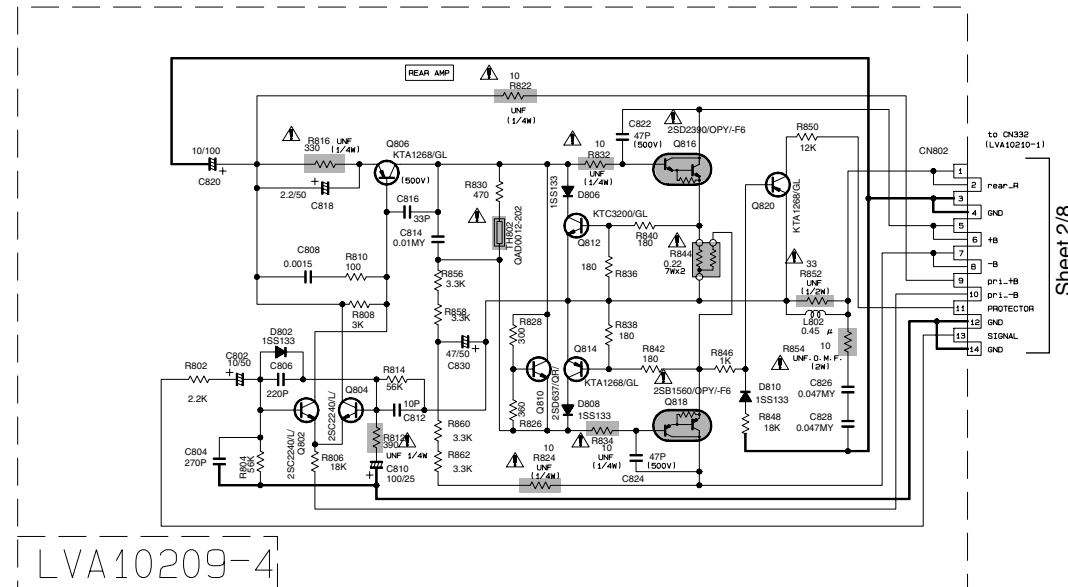
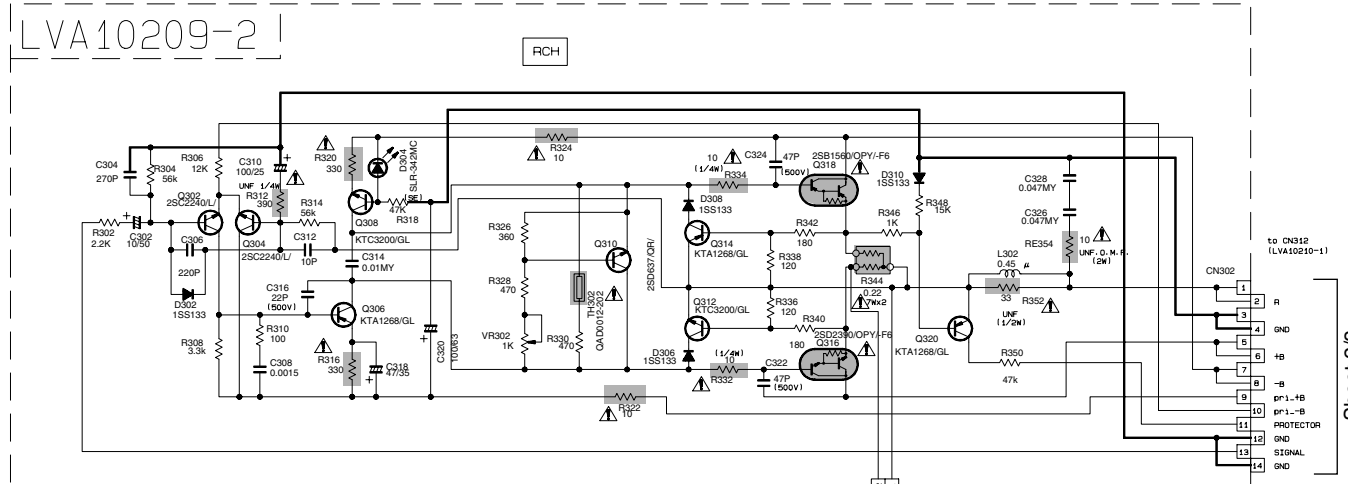

3

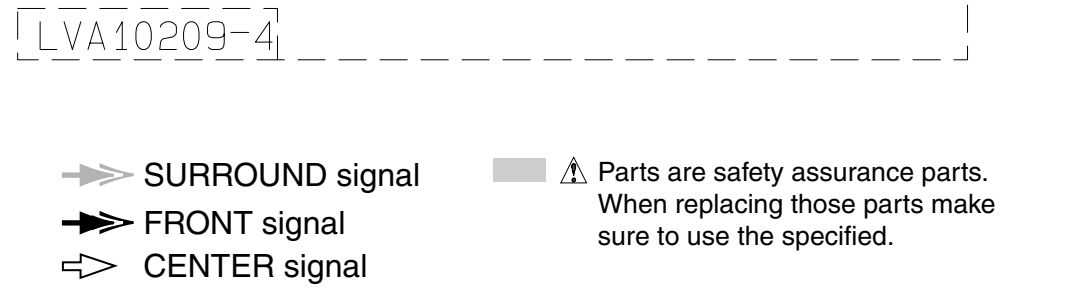
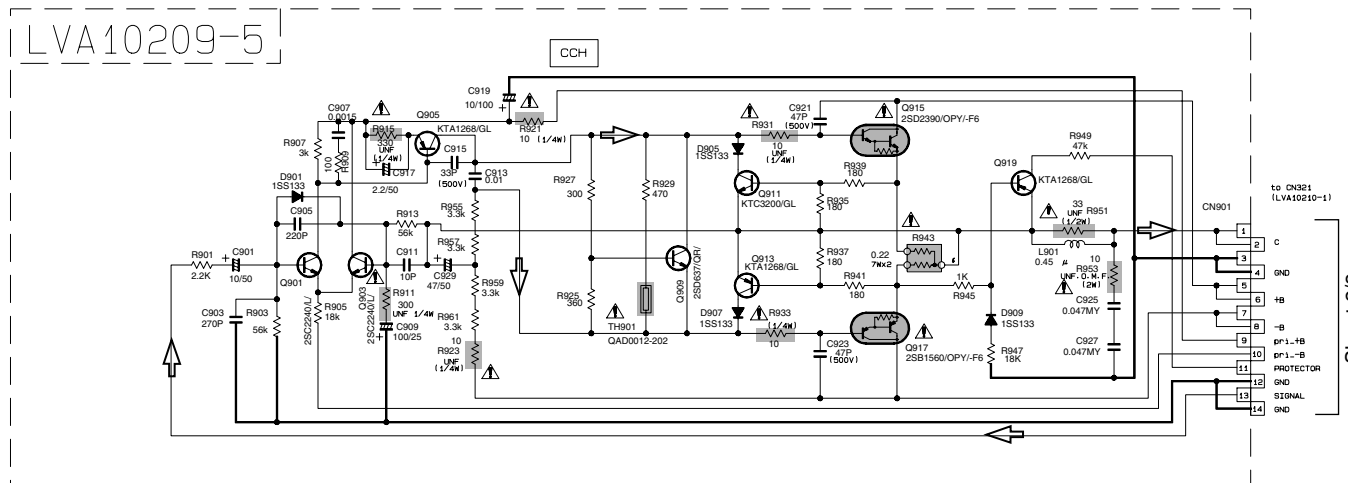

2

1

■ Main section

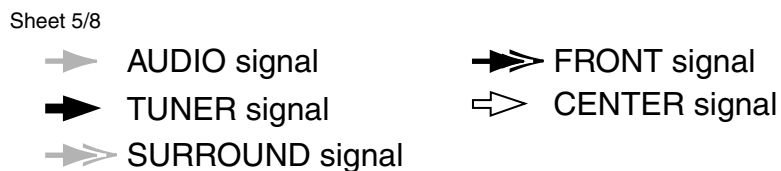
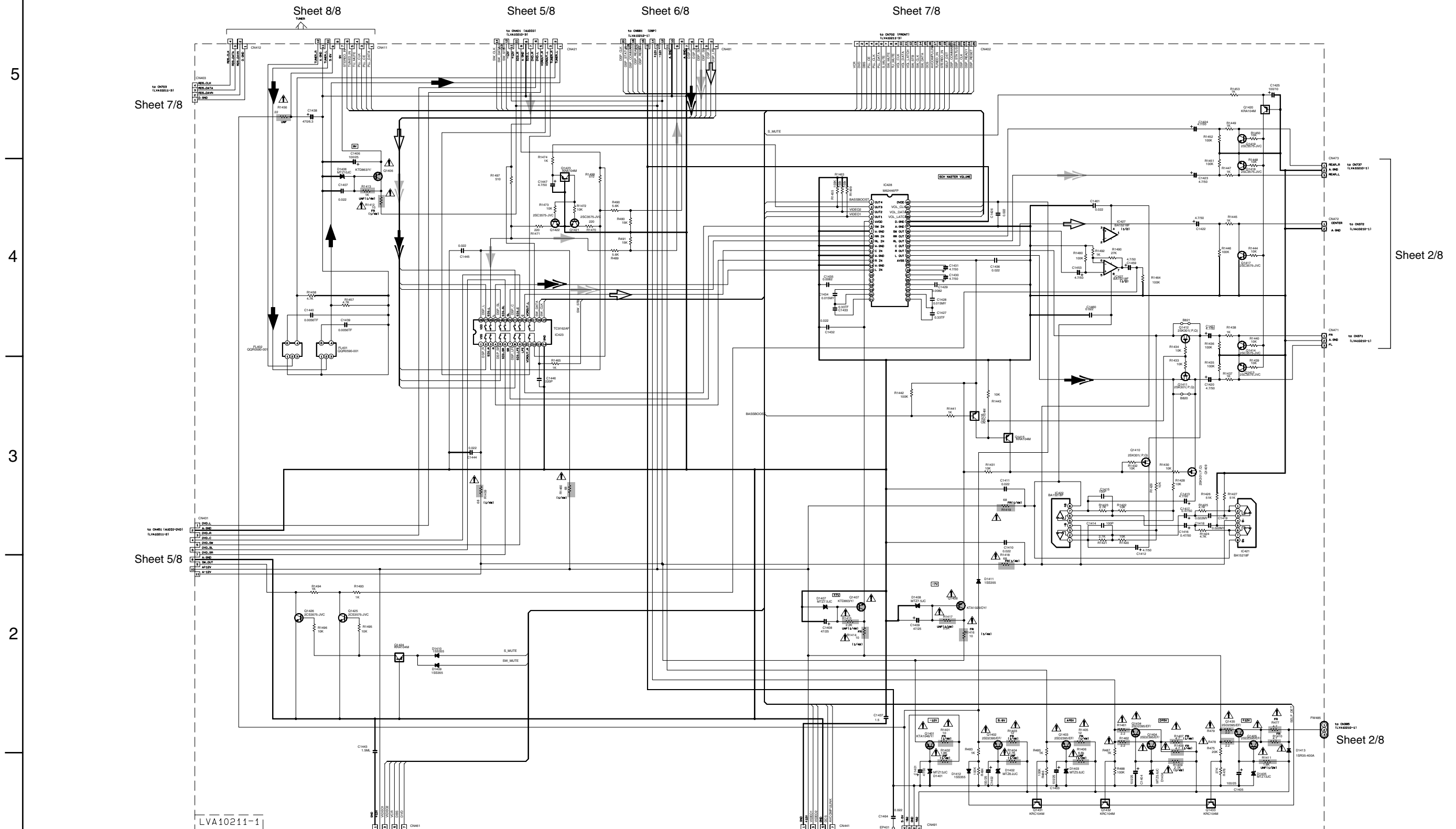

⚠ Parts are safety assurance parts. When replacing those parts make sure to use the specified.

■ Audio / Video / S Video / DVD signal input section

5

4

3

2

1

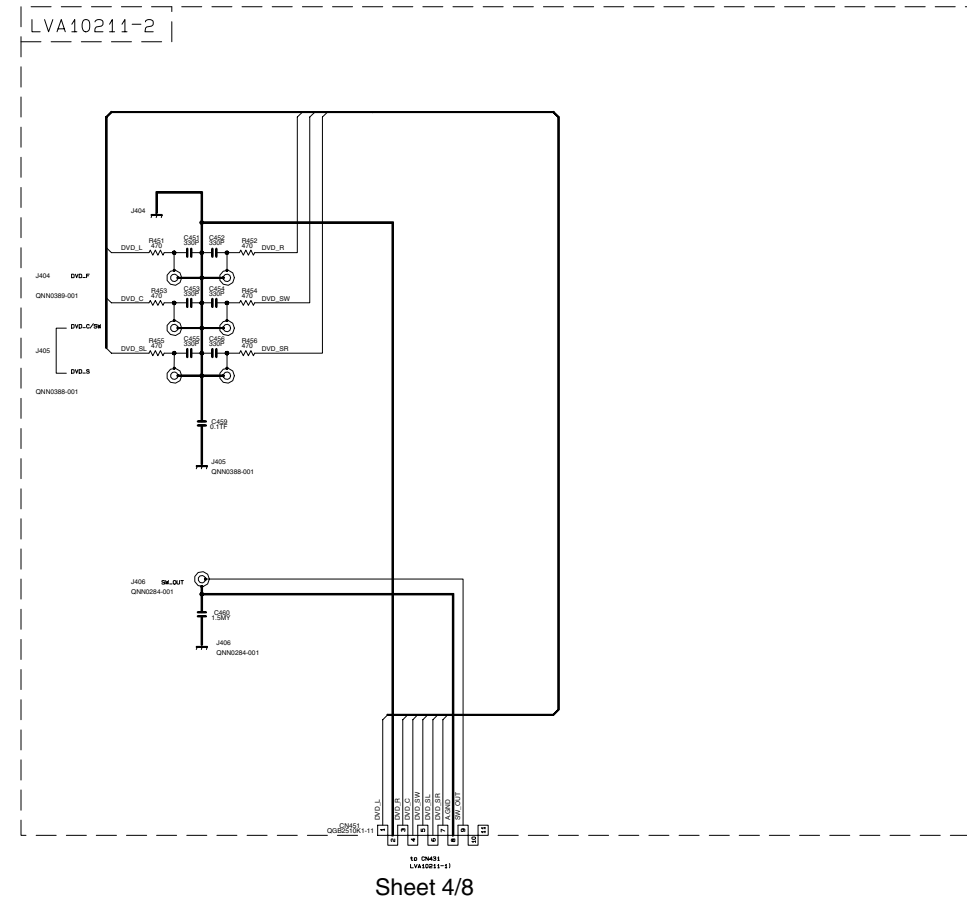
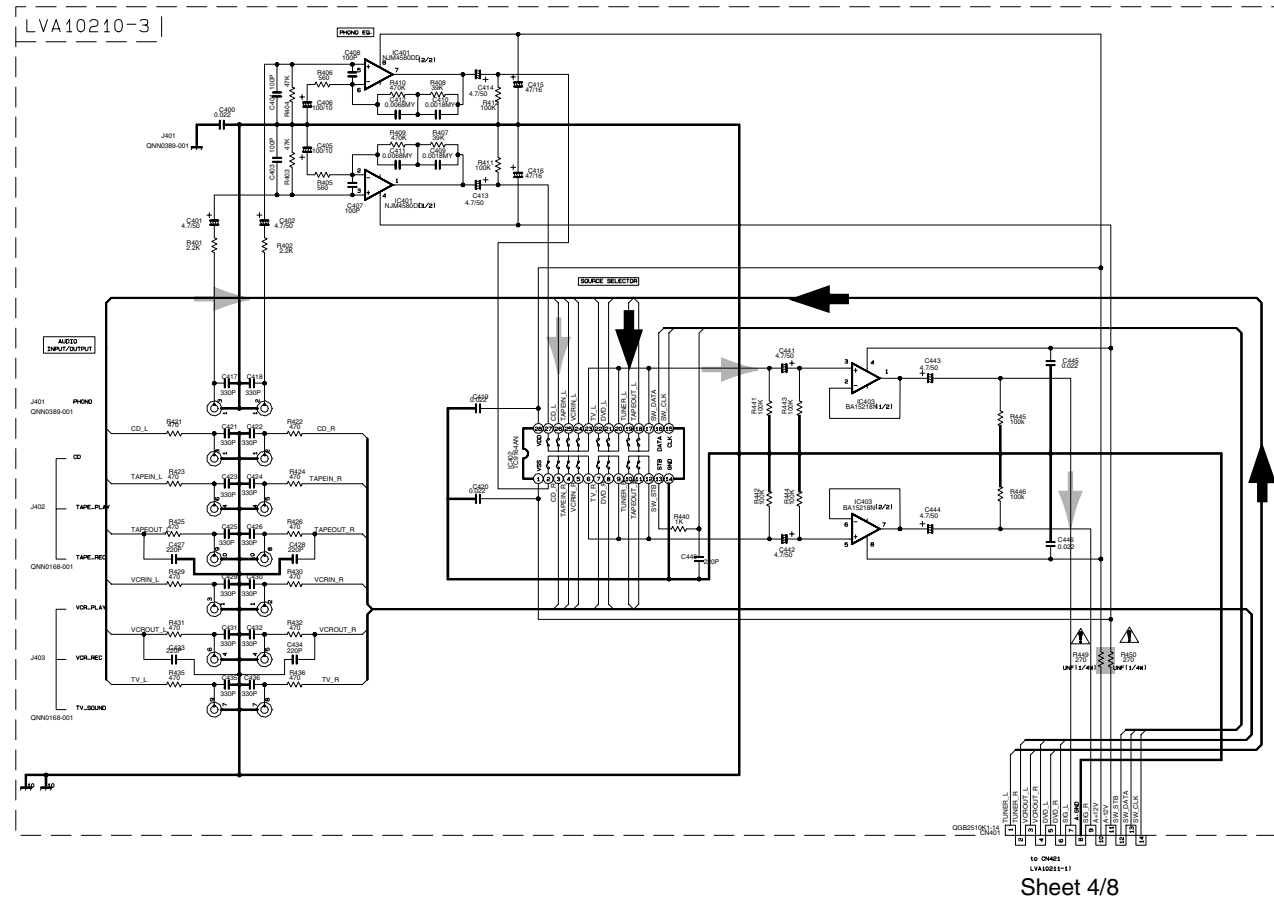

➤ AUDIO signal
➡ TUNER signal

⚠ Parts are safety assurance parts. When replacing those parts make sure to use the specified.

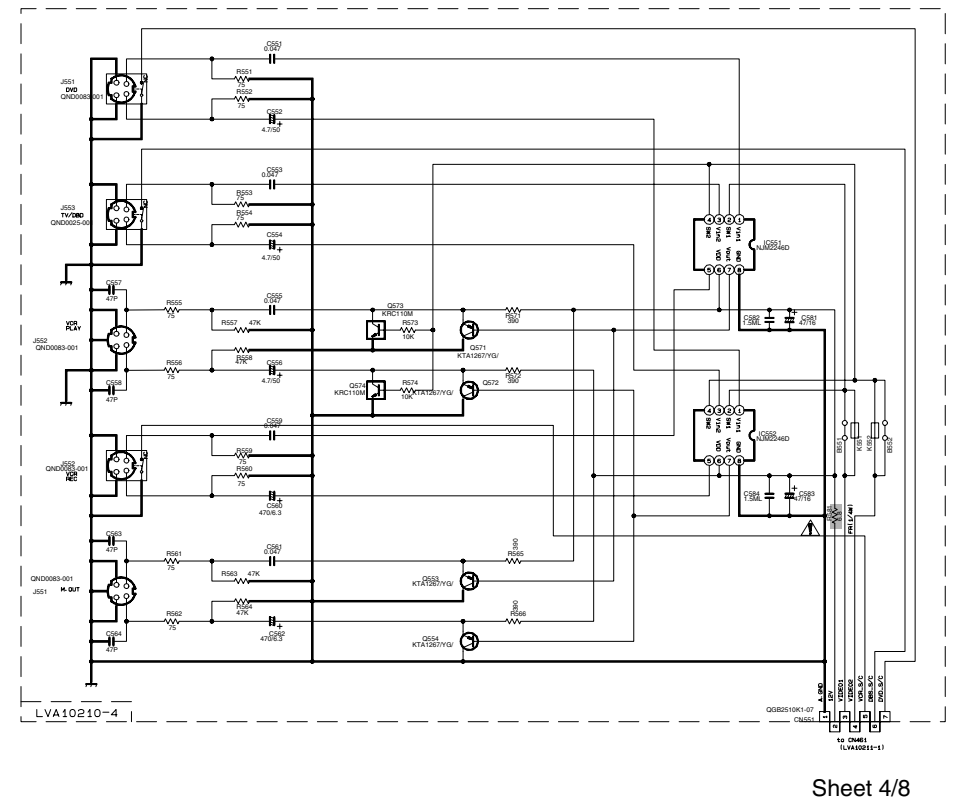
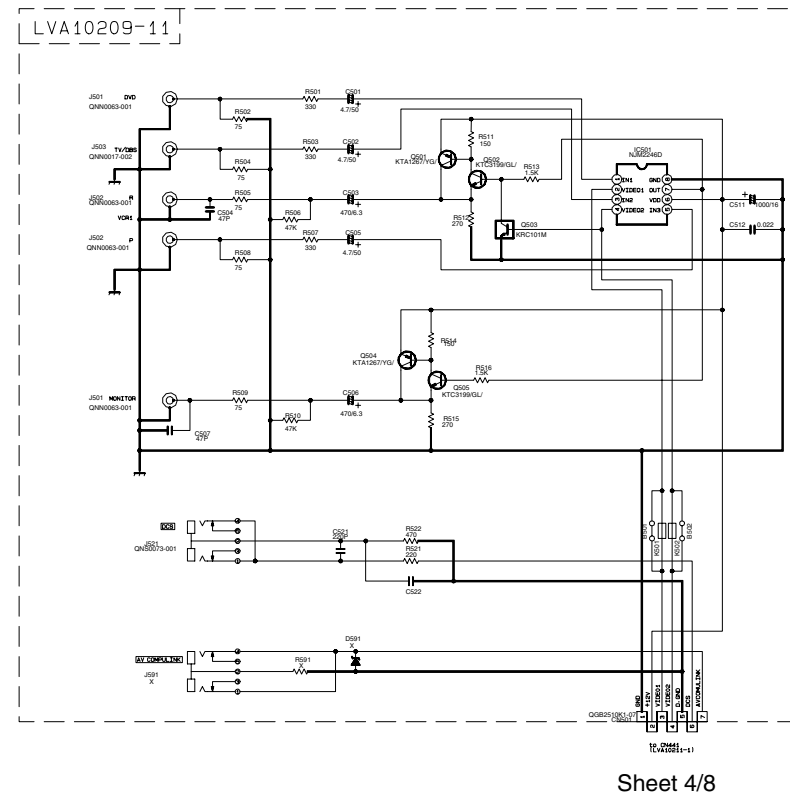

System control and FL displaying section

5

4

3

2

1

LVA10211-3

LVA10211-4

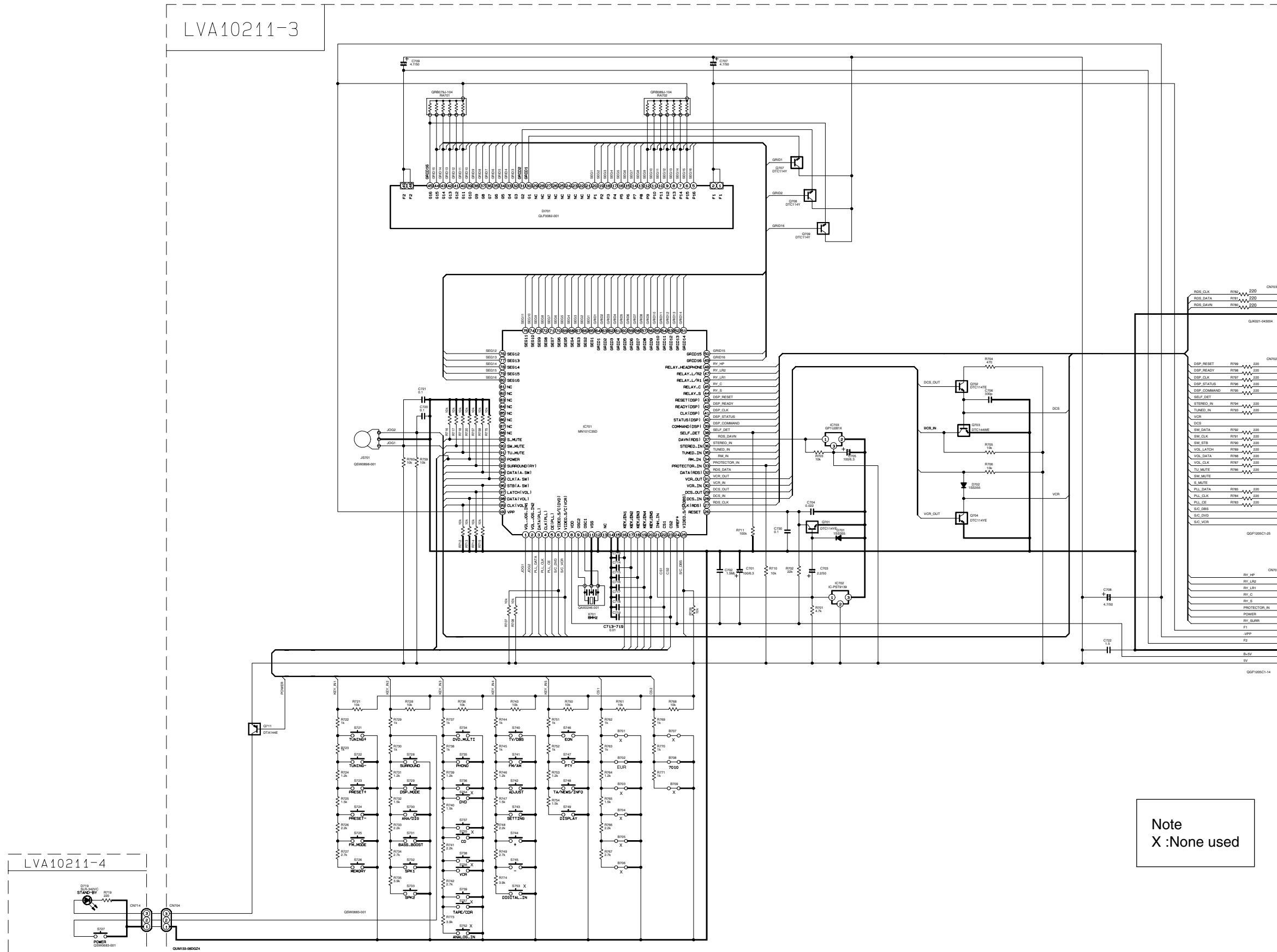

to CN402 (LVA10211-11) Sheet 4/8

to CN001 (LVA10209-61) Sheet 1/8

Tuner section

FOR E/EN/B (WITH RDS)
LVA10009

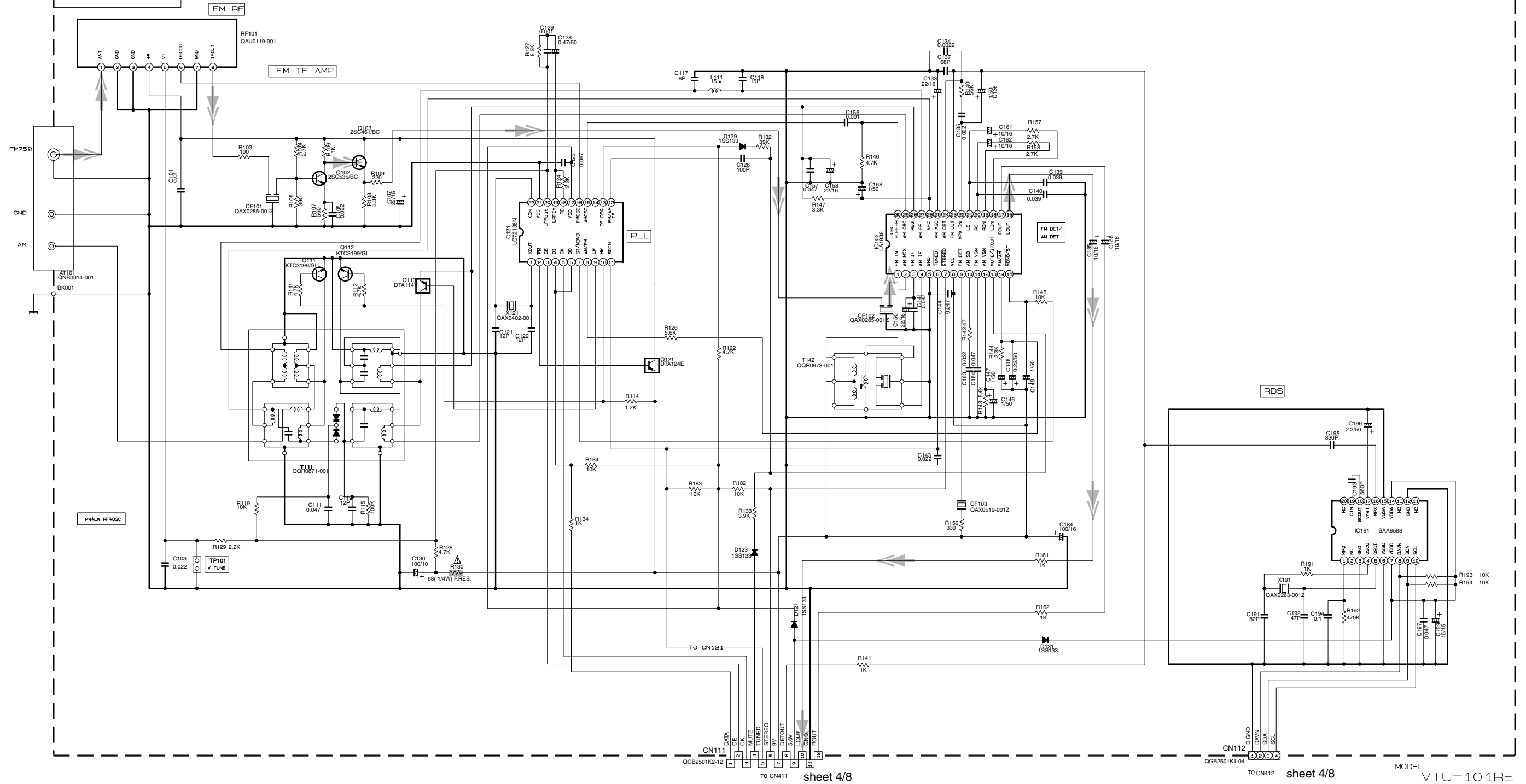

5
4
3
2
1

A B C D E F G

➔ FM / Tuner signal

⚠ Parts are safety assurance parts.
When replacing those parts make sure to use the specified one.

TO CN411 sheet 4/8 TO CN412 sheet 4/8 MODEL VTU-101RE

■ System control & Audio board

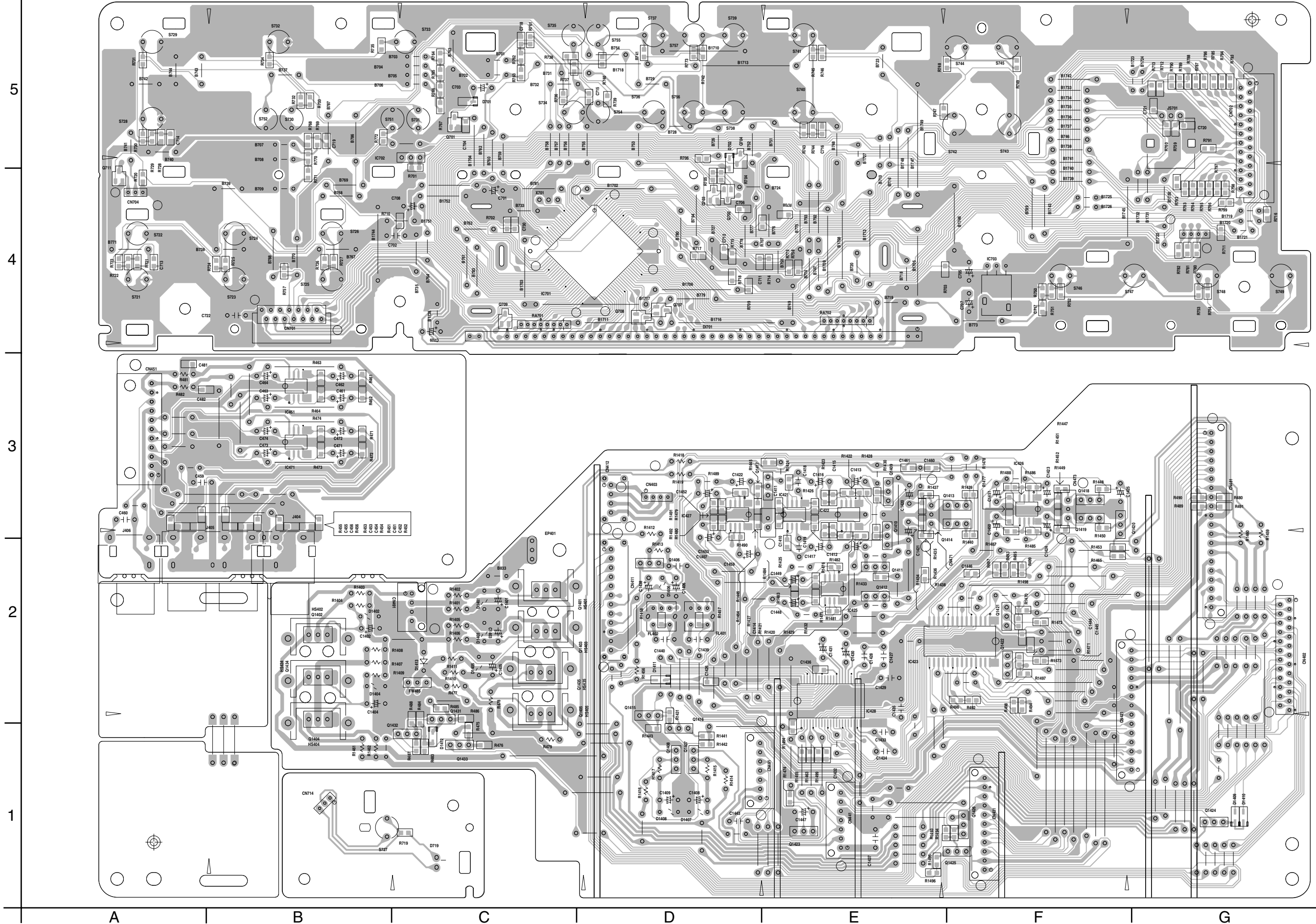

Power amp. board

5

4

3

2

1

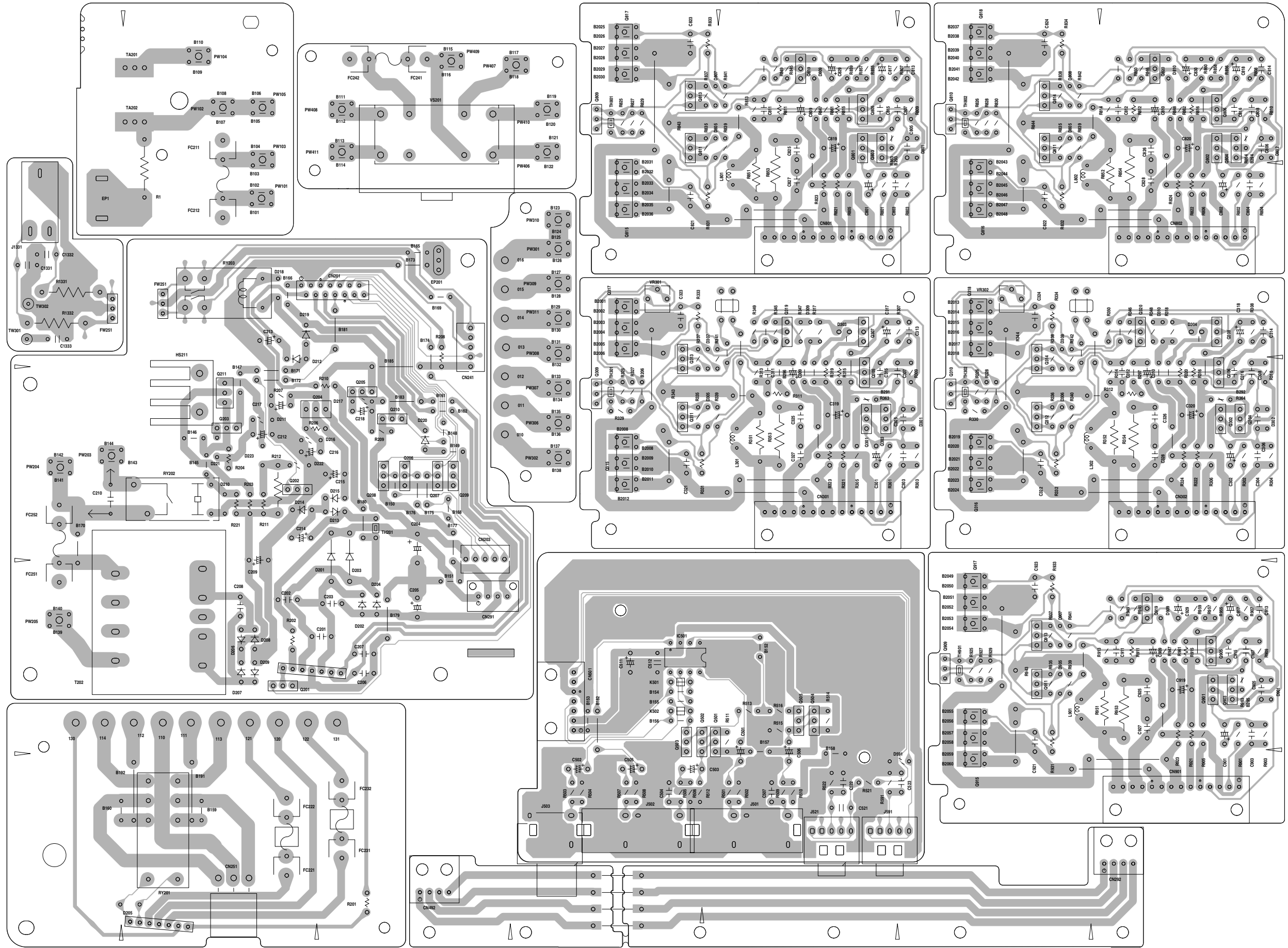

■ Tuner board

5
4
3
2
1

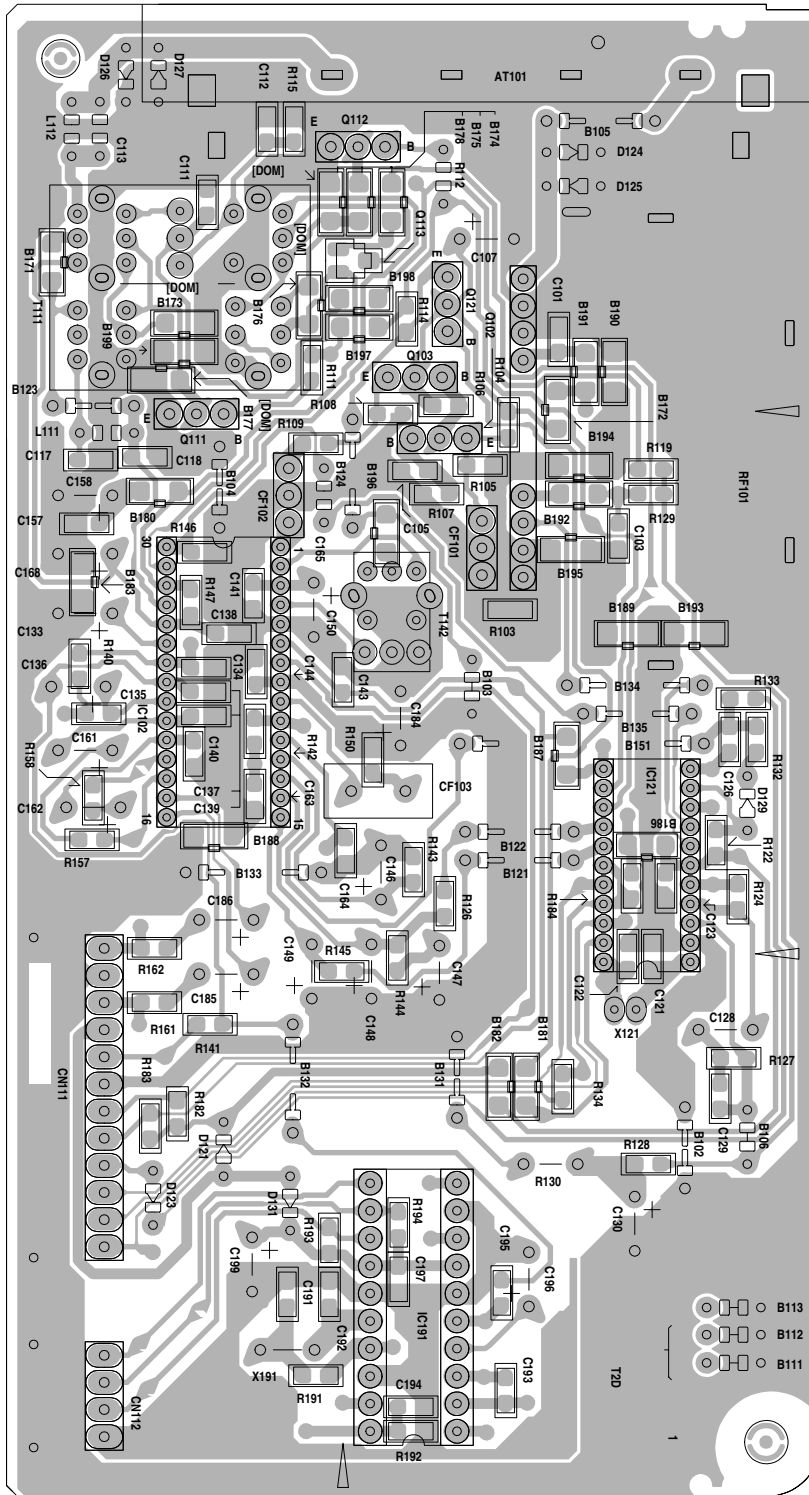

2-14 A B C D

PARTS LIST

[RX-7010RBK]
[RX-7012RSL]

* All printed circuit boards and its assemblies are not available as service parts.

Area suffix

E ----- Continental Europe
EN ----- Northern Europe

- Contents -

Exploded view of general assembly and parts list	3- 3
Electrical parts list	3- 5
Packing materials and accessories parts list	3-20

< MEMO >

Exploded view of general assembly and parts list

Block No. **M 1 M M**

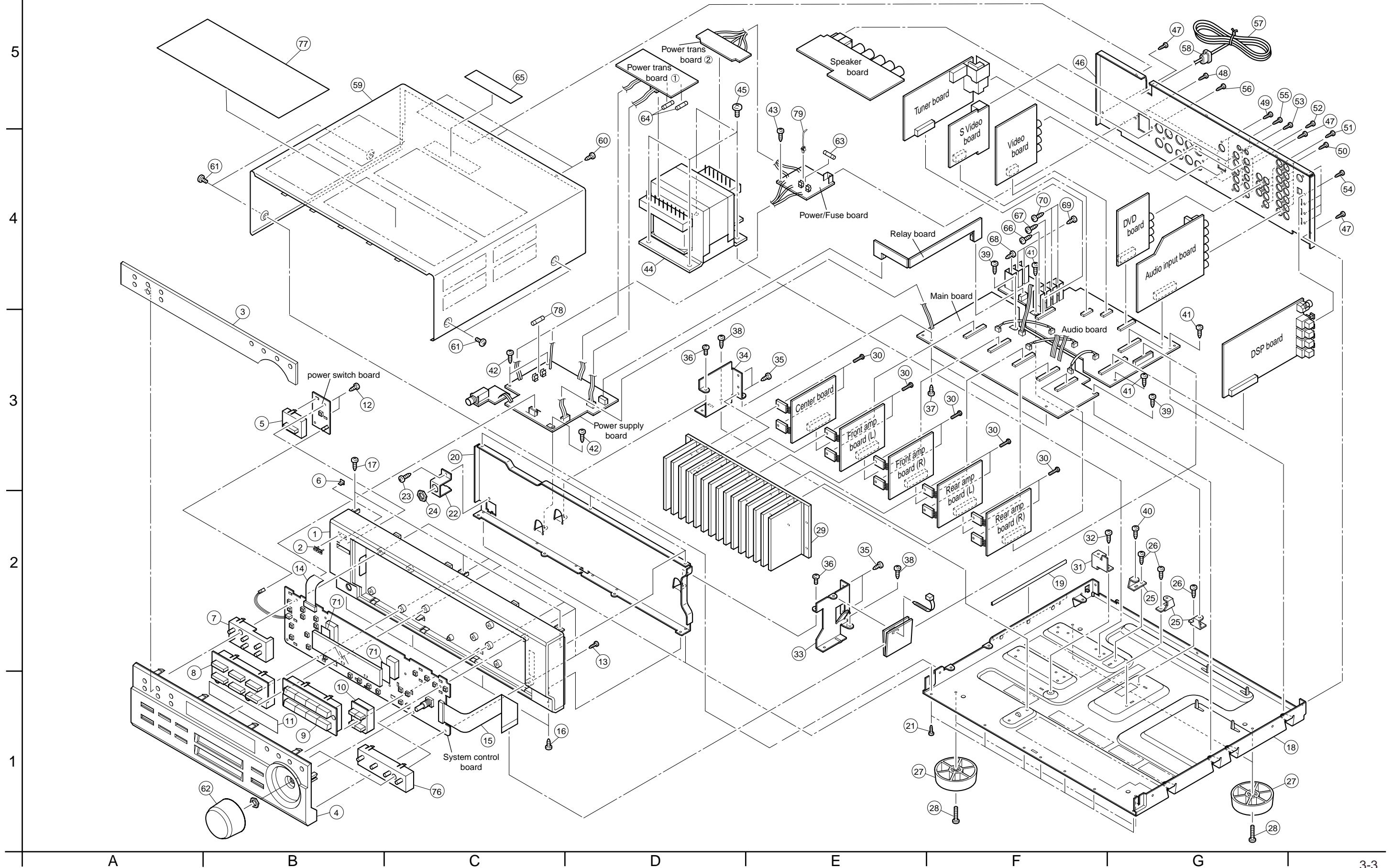

■ Parts list (General assembly)

Block No. M1MM

△	Item	Parts number	Parts name	Q'ty	Description	Area
	1	LV10457-004A	FRONT PANEL	1	RX-7012RSL	
		LV10457-003A	FRONT PANEL	1	RX-7010RBK	
	2	VJD5429-001SS	JVC MARK	1	RX-7010RBK	
		VJD5429-002SS	JVC MARK	1	RX-7012RSL	
	3	LV20950-002A	LENS	1		
	4	LV10459-002A	SUB PANEL	1	RX-7012RSL	
		LV10459-001A	SUB PANEL	1	RX-7010RBK	
	5	LV32431-004A	POWER BUTTON	1	RX-7010RBK	
		LV32431-002A	POWER BUTTON	1	RX-7012RSL	
	6	LV42096-001A	INDICATOR	1	POWER	
	7	LV20951-001A	PUSH BUTTON	1	TUNER	
	8	LV20919-002A	PUSH BUTTON(C)	1	RX-7012RSL	
		LV20919-001A	PUSH BUTTON(C)	1	RX-7010RBK	
	9	LV20917-001A	PUSH BUTTON(E)	1	RX-7010RBK	
		LV20917-002A	PUSH BUTTON(E)	1	RX-7012RSL	
	10	LV32430-001A	PUSH BUTTON(F)	1	RX-7010RBK	
		LV32430-002A	PUSH BUTTON(F)	1	RX-7012RSL	
	11	LV42095-001A	FL SCREEN	1		
	12	QYSBSF2610Z	SCREW	2	FRONT C.B	
	13	QYSBSF2610Z	SCREW	6	FRONT C.B FL	
	14	QUQ412-1415CJ	FFC WIRE	1		
	15	QUQ412-2538CJ	FFC WIRE	1		
	16	QYSDSG3006Z	SCREW	4	FRONT D	
	17	QYSBSG3006Z	T.SCREW	3	FRONT U	
	18	LV10019-003A	CHASSIS BASE	1		
	19	EXO150010H09S11	FELT SPACER	1	FOR C.BASE	
	20	LV10458-002A	FRONT BRACKET	1		
	21	QYSDSG3006Z	SCREW	7	C.B-F.B	
	22	LV42094-002A	H.P. BKT	1		
	23	QYSBSG3006Z	T.SCREW	1	H.P BKT-F.B	
	24	VKZ4150-001	SPECIAL NUT	1		
	25	E68587-223SM	CB BKT	3		
	26	QYSBST3006Z	T.SCREW	3	C.B-BKT	
	27	QZF6018-003	FOOT	4	RX-7012RSL	
		QZF6018-001	FOOT	4	RX-7010RBK	
	28	QYSBST3010Z	T.SCREW	4	FOOT	
	29	LV20916-002A	HEAT SINK	1		
	30	E73525-003SS	SCREW	10	TR	
	31	LV42098-001A	C.B BKT	1	PRI/SEC C.B	
	32	QYSBST3006Z	T.SCREW	1	C.B BKT	
	33	LV32433-001A	H.S BRACKET(R)	1		
	34	LV32434-001A	H.S BRACKET(L)	1		
	35	QYSBSG3008Z	T.SCREW	4	H.S-BKT	
	36	QYSBSG3006Z	T.SCREW	2	H.S BKT-F.BKT	
	37	QYSBSG3006Z	T.SCREW	2	H.S BKT	
	38	QYSBST3006Z	T.SCREW	2	H.S BKT-CHASSIS	
	39	QYSBSG3006Z	T.SCREW	2	M.C.B	
	40	E65923-003	TAPPING SCREW	1	M.C.B	

■ Parts list (General assembly)

Block No. M1MM

△	Item	Parts number	Parts name	Q'ty	Description	Area
	41	QYSBSG3006Z	T.SCREW	3	H.S-C.B	
	42	QYSBSG3006Z	T.SCREW	3	P.C.B-CHASSIS	
	43	QYSBSG3006Z	T.SCREW	1	C.B-CHASSIS	
△	44	QQT0316-001	POWER TRANSF	1	BANDO	
	45	QYSDSTL4008Z	SPECIAL SCREW	4	P.TRANS	
	46	LV20915-020A	REAR PANEL	1	RX-7012RSL	
		LV20915-019A	REAR PANEL	1	RX-7010RBK	
	47	QYSBSGY3008M	SPECIAL SCREW	3	R.P-C.BASE	
	48	QYSBSGY3008M	SPECIAL SCREW	1	R.P-ud---	
	49	QYSBSGY3008M	SPECIAL SCREW	2	TUNER	
	50	QYSBSGY3008M	SPECIAL SCREW	5	INPUT	
	51	QYSBSGY3008M	SPECIAL SCREW	3	V AUDIO	
	52	QYSBSGY3008M	SPECIAL SCREW	3	VIDEO	
	53	QYSBSGY3008M	SPECIAL SCREW	3	S VIDEO	
	54	QYSBSGY3008M	SPECIAL SCREW	5	DIGITAL	
	55	QYSBSGY3008M	SPECIAL SCREW	1	COMP C.B	
	56	QYSBSGY3008M	SPECIAL SCREW	5	SPK C.B	
△	57	QMPK150-200-JD	POWER CORD	1		
△	58	QZW0033-001	STRAIN RELIEF	1		
	59	LE20131-010A/S/	TOP COVER	1	RX-7010RBK	
		LE20131-011A/S/	METAL COVER	1	RX-7012RSL	
	60	QYSBSGY3008M	SPECIAL SCREW	3		
	61	E406308-004	SPECIAL SCREW	4	RX-7012RSL	
		E406308-003	SPECIAL SCREW	4	RX-7010RBK	
	62	LV32435-004A	VOLUME KNOB	1	RX-7012RSL	
		LV32435-003A	VOL KNOB	1	RX-7010RBK	
△	63	QMF51E2-2R5-J1	FUSE	1	F201	
△	64	QMF51E2-2R0-J1	FUSE	2	F202 F203	
	65	E409396-001	CAUTION LABEL	1		
	66	QYSBSG3008E	T.SCREW	1		
	67	QYSBSG3008E	T.SCREW	1		
	68	QYSBSG3008E	T.SCREW	1		
	69	QYSBSG3008E	T.SCREW	2		
	70	QYSBSG3008E	T.SCREW	2		
	71	LV30225-097A	SPACER	2		
	76	LV20952-001A	PUSH BUTTON	1	RDS	
	77	LV30077-006A	PROTECT SHEET	1	RX-7012RSL	
		LV30077-004A	PROTECT SHEET	1	RX-7010RBK	
△	78	QMF51E2-R10-J1	FUSE	1	F205	
	79	E307572-001	FASTENER	1		

■ Electrical parts list (Power amp board)

Block No. 01

△	Item	Parts number	Parts name	Remarks	Area	△	Item	Parts number	Parts name	Remarks	Area
	C 201	QFLC2AJ-104Z	M CAPACITOR	.10MF 5% 100V			C 811	QCS31HJ-100Z	C CAPACITOR	10PF 5% 50V	
	C 202	QFLC2AJ-104Z	M CAPACITOR	.10MF 5% 100V			C 812	QCS31HJ-100Z	C CAPACITOR	10PF 5% 50V	
	C 203	QFLC2AJ-104Z	M CAPACITOR	.10MF 5% 100V			C 813	QFLC1HJ-103Z	M CAPACITOR	.010MF 5% 50V	
	C 204	QETM1VM-228	E CAPACITOR	2200MF 20% 35V			C 814	QFLC1HJ-103Z	M CAPACITOR	.010MF 5% 50V	
	C 205	QETM1VM-108	E CAPACITOR	1000MF 20% 35V			C 815	QCS32HJ-330Z	C CAPACITOR	33PF 5% 500V	
	C 206	QFLC1HJ-473Z	M CAPACITOR	.047MF 5% 50V			C 816	QCS32HJ-330Z	C CAPACITOR	33PF 5% 500V	
	C 207	QFLC1HJ-473Z	M CAPACITOR	.047MF 5% 50V			C 817	QEHR1HM-225Z	E CAPACITOR	2.2MF 20% 50V	
	C 208	QFLC2AJ-472Z	M CAPACITOR	4700PF 5% 100V			C 818	QEHR1HM-225Z	E CAPACITOR	2.2MF 20% 50V	
	C 209	QETN1EM-477Z	E CAPACITOR	470MF 20% 25V			C 819	QEHR2AM-106Z	E CAPACITOR	10MF 20% 100V	
△	C 210	QCZ9104-472	C CAPACITOR	4700PF			C 820	QEHR2AM-106Z	E CAPACITOR	10MF 20% 100V	
	C 212	QETN1CM-477Z	E CAPACITOR	470MF 20% 16V			C 821	QCS32HJ-470Z	C CAPACITOR	47PF 5% 500V	
	C 213	QETM0JM-228	E CAPACITOR	2200MF 20% 6.3V			C 822	QCS32HJ-470Z	C CAPACITOR	47PF 5% 500V	
	C 218	QETN1HM-105Z	E CAPACITOR	1.0MF 20% 50V			C 823	QCS32HJ-470Z	C CAPACITOR	47PF 5% 500V	
	C 221	QCS31HJ-471Z	C CAPACITOR	470PF 5% 50V			C 824	QCS32HJ-470Z	C CAPACITOR	47PF 5% 500V	
	C 301	QEHR1HM-106Z	E CAPACITOR	10MF 20% 50V			C 825	QFLC1HJ-473Z	M CAPACITOR	.047MF 5% 50V	
	C 302	QEHR1HM-106Z	E CAPACITOR	10MF 20% 50V			C 826	QFLC1HJ-473Z	M CAPACITOR	.047MF 5% 50V	
	C 303	QCS31HJ-271Z	C CAPACITOR	270PF 5% 50V			C 827	QFLC1HJ-473Z	M CAPACITOR	.047MF 5% 50V	
	C 304	QCS31HJ-271Z	C CAPACITOR	270PF 5% 50V			C 828	QFLC1HJ-473Z	M CAPACITOR	.047MF 5% 50V	
	C 305	QCS31HJ-221Z	C CAPACITOR	220PF 5% 50V			C 829	QETN1HM-476Z	E CAPACITOR	47MF 20% 50V	
	C 306	QCS31HJ-221Z	C CAPACITOR	220PF 5% 50V			C 830	QETN1HM-476Z	E CAPACITOR	47MF 20% 50V	
	C 307	QCB31HK-152Z	C CAPACITOR	1500PF 10% 50V			C 901	QEHR1HM-106Z	E CAPACITOR	10MF 20% 50V	
	C 308	QCB31HK-152Z	C CAPACITOR	1500PF 10% 50V			C 903	QCS31HJ-271Z	C CAPACITOR	270PF 5% 50V	
	C 309	QETN1EM-107Z	E CAPACITOR	100MF 20% 25V			C 905	QCS31HJ-221Z	C CAPACITOR	220PF 5% 50V	
	C 310	QETN1EM-107Z	E CAPACITOR	100MF 20% 25V			C 907	QCB31HK-152Z	C CAPACITOR	1500PF 10% 50V	
	C 311	QCS31HJ-100Z	C CAPACITOR	10PF 5% 50V			C 909	QETN1EM-107Z	E CAPACITOR	100MF 20% 25V	
	C 312	QCS31HJ-100Z	C CAPACITOR	10PF 5% 50V			C 911	QCS31HJ-100Z	C CAPACITOR	10PF 5% 50V	
	C 313	QFLC1HJ-103Z	M CAPACITOR	.010MF 5% 50V			C 913	QFLC1HJ-103Z	M CAPACITOR	.010MF 5% 50V	
	C 314	QFLC1HJ-103Z	M CAPACITOR	.010MF 5% 50V			C 915	QCS32HJ-330Z	C CAPACITOR	33PF 5% 500V	
	C 315	QCS32HJ-220Z	C CAPACITOR	22PF 5% 500V			C 917	QEHR1HM-225Z	E CAPACITOR	2.2MF 20% 50V	
	C 316	QCS32HJ-220Z	C CAPACITOR	22PF 5% 500V			C 919	QEHR2AM-106Z	E CAPACITOR	10MF 20% 100V	
	C 317	QEHR1VM-476Z	E CAPACITOR	47MF 20% 35V			C 921	QCS32HJ-470Z	C CAPACITOR	47PF 5% 500V	
	C 318	QEHR1VM-476Z	E CAPACITOR	47MF 20% 35V			C 923	QCS32HJ-470Z	C CAPACITOR	47PF 5% 500V	
	C 319	QETN1JM-107Z	E CAPACITOR	100MF 20% 63V			C 925	QFLC1HJ-473Z	M CAPACITOR	.047MF 5% 50V	
	C 320	QETN1JM-107Z	E CAPACITOR	100MF 20% 63V			C 927	QFLC1HJ-473Z	M CAPACITOR	.047MF 5% 50V	
	C 321	QCS32HJ-470Z	C CAPACITOR	47PF 5% 500V			C 929	QETN1HM-476Z	E CAPACITOR	47MF 20% 50V	
	C 322	QCS32HJ-470Z	C CAPACITOR	47PF 5% 500V			CN201	QGF1205C1-14	CONNECTOR		
	C 323	QCS32HJ-470Z	C CAPACITOR	47PF 5% 500V			CN203	QGD2501C1-05Z	SOCKET		
	C 324	QCS32HJ-470Z	C CAPACITOR	47PF 5% 500V			CN241	QGD2501C1-05Z	SOCKET		
	C 325	QFLC1HJ-473Z	M CAPACITOR	.047MF 5% 50V			CN251	QGA3901F2-03	CONNECTOR		
	C 326	QFLC1HJ-473Z	M CAPACITOR	.047MF 5% 50V			CN291	QGB2510J1-04	CONNECTOR		
	C 327	QFLC1HJ-473Z	M CAPACITOR	.047MF 5% 50V			CN292	QGB2510K1-04	CONNECTOR		
	C 328	QFLC1HJ-473Z	M CAPACITOR	.047MF 5% 50V			CN301	QGB2510K1-14	CONNECTOR		
	C 501	QETN1HM-475Z	E CAPACITOR	4.7MF 20% 50V			CN302	QGB2510K1-14	CONNECTOR		
	C 502	QETN1HM-475Z	E CAPACITOR	4.7MF 20% 50V			CN492	QGB2510K1-04	CONNECTOR		
	C 503	QETN0JM-477Z	E CAPACITOR	470MF 20% 6.3V			CN501	QGB2510K1-07	CONNECTOR		
	C 504	QCS31HJ-470Z	C CAPACITOR	47PF 5% 50V			CN801	QGB2510K1-14	CONNECTOR		
	C 505	QETN1HM-475Z	E CAPACITOR	4.7MF 20% 50V			CN802	QGB2510K1-14	CONNECTOR		
	C 506	QETN0JM-477Z	E CAPACITOR	470MF 20% 6.3V			CN901	QGB2510K1-14	CONNECTOR		
	C 507	QCS31HJ-470Z	C CAPACITOR	47PF 5% 50V			C1331	QDGB1HK-102Y	C CAPACITOR		
	C 511	QETN1CM-108Z	E CAPACITOR	1000MF 20% 16V			C1332	QDGB1HK-102Y	C CAPACITOR		
	C 512	QCB1HK-223Y	C CAPACITOR	.022MF 10% 50V			△	D 201	10E2-FD	DIODE	
	C 521	QCB1HK-221Y	C CAPACITOR	220PF 10% 50V			△	D 202	1SR35-400A-T5	DIODE	
	C 522	QCZ0202-155Z	ML C CAPACITOR	1.5MF			△	D 203	10E2-FD	DIODE	
	C 801	QEHR1HM-106Z	E CAPACITOR	10MF 20% 50V			△	D 204	1SR35-400A-T5	DIODE	
	C 802	QEHR1HM-106Z	E CAPACITOR	10MF 20% 50V			△	D 206	1SR35-400A-T5	DIODE	
	C 803	QCS31HJ-271Z	C CAPACITOR	270PF 5% 50V			△	D 207	1SR35-400A-T5	DIODE	
	C 804	QCS31HJ-271Z	C CAPACITOR	270PF 5% 50V			△	D 208	1SR35-400A-T5	DIODE	
	C 805	QCS31HJ-221Z	C CAPACITOR	220PF 5% 50V			△	D 209	1SR35-400A-T5	DIODE	
	C 806	QCS31HJ-221Z	C CAPACITOR	220PF 5% 50V				D 210	1SS133-T2	SI DIODE	
	C 807	QCB31HK-152Z	C CAPACITOR	1500PF 10% 50V				D 211	MTZJ6.8C-T2	Z DIODE	
	C 808	QCB31HK-152Z	C CAPACITOR	1500PF 10% 50V				D 212	1SR139-400-T4	DIODE	
	C 809	QETN1EM-107Z	E CAPACITOR	100MF 20% 25V				D 217	MTZJ6.2C-T2	Z DIODE	
	C 810	QETN1EM-107Z	E CAPACITOR	100MF 20% 25V				D 218	1SS133-T2	SI DIODE	

■ Electrical parts list (Power amp board)

Block No. 01

△	Item	Parts number	Parts name	Remarks	Area	△	Item	Parts number	Parts name	Remarks	Area
	D 219	1SR139-400-T4	DIODE				Q 308	KTC3200/GL/-T	TRANSISTOR		
	D 220	1SR139-400-T4	DIODE				Q 309	2SD637/QR/	TRANSISTOR		
	D 221	1SS133-T2	SI DIODE				Q 310	2SD637/QR/	TRANSISTOR		
	D 301	1SS133-T2	SI DIODE				Q 311	KTC3200/GL/-T	TRANSISTOR		
	D 302	1SS133-T2	SI DIODE				Q 312	KTC3200/GL/-T	TRANSISTOR		
	D 303	SLR-342MC-T	LED				Q 313	KTA1268/GL/-T	TRANSISTOR		
	D 304	SLR-342MC-T	LED				Q 314	KTA1268/GL/-T	TRANSISTOR		
	D 305	1SS133-T2	SI DIODE			△	Q 315	2SD2390/OPY/-F6	TRANSISTOR	FOR OTHER	
	D 306	1SS133-T2	SI DIODE			△	Q 316	2SD2390/OPY/-F6	TRANSISTOR	FOR OTHER	
	D 307	1SS133-T2	SI DIODE			△	Q 317	2SB1560/OPY/-F6	TRANSISTOR	FOR OTHER	
	D 308	1SS133-T2	SI DIODE			△	Q 318	2SB1560/OPY/-F6	TRANSISTOR	FOR OTHER	
	D 309	1SS133-T2	SI DIODE				Q 319	KTA1268/GL/-T	TRANSISTOR		
	D 310	1SS133-T2	SI DIODE				Q 320	KTA1268/GL/-T	TRANSISTOR		
	D 801	1SS133-T2	SI DIODE				Q 501	KTA1267/YG/-T	TRANSISTOR		
	D 802	1SS133-T2	SI DIODE				Q 502	KTC3199/GL/-T	TRANSISTOR		
	D 805	1SS133-T2	SI DIODE				Q 503	KRC101M-T	TRANSISTOR		
	D 806	1SS133-T2	SI DIODE				Q 504	KTA1267/YG/-T	TRANSISTOR		
	D 807	1SS133-T2	SI DIODE				Q 505	KTC3199/GL/-T	TRANSISTOR		
	D 808	1SS133-T2	SI DIODE				Q 801	2SC2240/L/-T	TRANSISTOR		
	D 809	1SS133-T2	SI DIODE				Q 802	2SC2240/L/-T	TRANSISTOR		
	D 810	1SS133-T2	SI DIODE				Q 803	2SC2240/L/-T	TRANSISTOR		
	D 901	1SS133-T2	SI DIODE				Q 804	2SC2240/L/-T	TRANSISTOR		
	D 905	1SS133-T2	SI DIODE				Q 805	KTA1268/GL/-T	TRANSISTOR		
	D 907	1SS133-T2	SI DIODE				Q 806	KTA1268/GL/-T	TRANSISTOR		
	D 909	1SS133-T2	SI DIODE				Q 809	2SD637/QR/	TRANSISTOR		
	EP 1	E409182-001SM	GRAND TERMINAL				Q 810	2SD637/QR/	TRANSISTOR		
	EP201	QNZ0136-001Z	EARTH PLATE				Q 811	KTC3200/GL/-T	TRANSISTOR		
	FC211	QNG0020-001Z	FUSE CLIP				Q 812	KTC3200/GL/-T	TRANSISTOR		
	FC212	QNG0020-001Z	FUSE CLIP				Q 813	KTA1268/GL/-T	TRANSISTOR		
	FC221	QNG0020-001Z	FUSE CLIP				Q 814	KTA1268/GL/-T	TRANSISTOR		
	FC222	QNG0020-001Z	FUSE CLIP			△	Q 815	2SD2390/OPY/-F6	TRANSISTOR	FOR OTHER	
	FC231	QNG0020-001Z	FUSE CLIP			△	Q 816	2SD2390/OPY/-F6	TRANSISTOR	FOR OTHER	
	FC232	QNG0020-001Z	FUSE CLIP			△	Q 817	2SB1560/OPY/-F6	TRANSISTOR	FOR OTHER	
	FC251	QNG0020-001Z	FUSE CLIP	F205		△	Q 818	2SB1560/OPY/-F6	TRANSISTOR	FOR OTHER	
	FC252	QNG0020-001Z	FUSE CLIP	F205			Q 819	KTA1268/GL/-T	TRANSISTOR		
	FW201	QUM137-13Z4Z4	PARA RIBON WIRE				Q 820	KTA1268/GL/-T	TRANSISTOR		
	FW251	QUM133-08Z4Z4	PARA RIBON WIRE				Q 901	2SC2240/L/-T	TRANSISTOR		
	IC501	NJM2246D	IC				Q 903	2SC2240/L/-T	TRANSISTOR		
	J 501	QNN0063-001	PIN JACK	VCR(R/P)			Q 905	KTA1268/GL/-T	TRANSISTOR		
	J 502	QNN0063-001	PIN JACK	DBS			Q 909	2SD637/QR/	TRANSISTOR		
	J 503	QNN0017-002	PIN JACK				Q 911	KTC3200/GL/-T	TRANSISTOR		
	J 521	QNS0073-001	JACK				Q 913	KTA1268/GL/-T	TRANSISTOR		
	J1331	QNS0022-001	JACK			△	Q 915	2SD2390/OPY/-F6	TRANSISTOR	FOR OTHER	
	L 301	QQLZ005-R45	INDUCTOR			△	Q 917	2SB1560/OPY/-F6	TRANSISTOR	FOR OTHER	
	L 302	QQLZ005-R45	INDUCTOR				Q 919	KTA1268/GL/-T	TRANSISTOR		
	L 801	QQLZ005-R45	INDUCTOR			△	R 201	QRJ146J-4R7X	UNF C RESISTOR	4.7 5% 1/4W	
	L 802	QQLZ005-R45	INDUCTOR			△	R 203	QRJ146J-100X	UNF C RESISTOR	10 5% 1/4W	
	L 901	QQLZ005-R45	INDUCTOR			△	R 204	QRJ146J-821X	UNF C RESISTOR	820 5% 1/4W	
	Q 202	KRC105M-T	D TRANSISTOR			△	R 208	QRJ146J-100X	UNF C RESISTOR	10 5% 1/4W	
	Q 203	KTC3203/OY/-T	TRANSISTOR				R 209	QRE141J-104Y	C RESISTOR	100K 5% 1/4W	
	Q 205	KTC3200/GL/-T	TRANSISTOR			△	R 210	QRJ146J-680X	UNF C RESISTOR	68 5% 1/4W	
	Q 206	KRC105M-T	D TRANSISTOR			△	R 221	QRJ146J-100X	UNF C RESISTOR	10 5% 1/4W	
	Q 207	KRC105M-T	D TRANSISTOR				R 301	QRE141J-222Y	C RESISTOR	2.2K 5% 1/4W	
	Q 208	KRC105M-T	D TRANSISTOR				R 302	QRE141J-222Y	C RESISTOR	2.2K 5% 1/4W	
	Q 209	KRC105M-T	D TRANSISTOR				R 303	QRE141J-563Y	C RESISTOR	56K 5% 1/4W	
	Q 210	KRC105M-T	D TRANSISTOR				R 304	QRE141J-563Y	C RESISTOR	56K 5% 1/4W	
	Q 301	2SC2240/L/-T	TRANSISTOR				R 305	QRE141J-153Y	C RESISTOR	15K 5% 1/4W	
	Q 302	2SC2240/L/-T	TRANSISTOR				R 306	QRE141J-153Y	C RESISTOR	15K 5% 1/4W	
	Q 303	2SC2240/L/-T	TRANSISTOR				R 307	QRE141J-272Y	C RESISTOR	2.7K 5% 1/4W	
	Q 304	2SC2240/L/-T	TRANSISTOR				R 308	QRE141J-272Y	C RESISTOR	2.7K 5% 1/4W	
	Q 305	KTA1268/GL/-T	TRANSISTOR				R 309	QRE141J-101Y	C RESISTOR	100 5% 1/4W	
	Q 306	KTA1268/GL/-T	TRANSISTOR				R 310	QRE141J-101Y	C RESISTOR	100 5% 1/4W	
	Q 307	KTC3200/GL/-T	TRANSISTOR			△	R 311	QRJ146J-391X	UNF C RESISTOR	390 5% 1/4W	

■ Electrical parts list (Power amp board)

Block No. 01

△	Item	Parts number	Parts name	Remarks	Area	△	Item	Parts number	Parts name	Remarks	Area
△	R 312	QRJ146J-391X	UNF C RESISTOR	390 5% 1/4W			R 803	QRE141J-563Y	C RESISTOR	56K 5% 1/4W	
	R 313	QRE141J-563Y	C RESISTOR	56K 5% 1/4W			R 804	QRE141J-563Y	C RESISTOR	56K 5% 1/4W	
	R 314	QRE141J-563Y	C RESISTOR	56K 5% 1/4W			R 805	QRE141J-183Y	C RESISTOR	18K 5% 1/4W	
△	R 315	QRJ146J-271X	UNF C RESISTOR	270 5% 1/4W			R 806	QRE141J-183Y	C RESISTOR	18K 5% 1/4W	
△	R 316	QRJ146J-271X	UNF C RESISTOR	270 5% 1/4W			R 807	QRE141J-302Y	C RESISTOR	3.0K 5% 1/4W	
	R 317	QRE141J-473Y	C RESISTOR	47K 5% 1/4W			R 808	QRE141J-302Y	C RESISTOR	3.0K 5% 1/4W	
	R 318	QRE141J-473Y	C RESISTOR	47K 5% 1/4W			R 809	QRE141J-101Y	C RESISTOR	100 5% 1/4W	
△	R 319	QRJ146J-471X	UNF C RESISTOR	470 5% 1/4W			R 810	QRE141J-101Y	C RESISTOR	100 5% 1/4W	
△	R 320	QRJ146J-471X	UNF C RESISTOR	470 5% 1/4W		△	R 811	QRJ146J-391X	UNF C RESISTOR	390 5% 1/4W	
△	R 321	QRJ146J-100X	UNF C RESISTOR	10 5% 1/4W		△	R 812	QRJ146J-391X	UNF C RESISTOR	390 5% 1/4W	
△	R 322	QRJ146J-100X	UNF C RESISTOR	10 5% 1/4W			R 813	QRE141J-563Y	C RESISTOR	56K 5% 1/4W	
△	R 323	QRJ146J-100X	UNF C RESISTOR	10 5% 1/4W			R 814	QRE141J-563Y	C RESISTOR	56K 5% 1/4W	
△	R 324	QRJ146J-100X	UNF C RESISTOR	10 5% 1/4W		△	R 815	QRJ146J-331X	UNF C RESISTOR	330 5% 1/4W	
	R 325	QRE141J-361Y	C RESISTOR	360 5% 1/4W		△	R 816	QRJ146J-331X	UNF C RESISTOR	330 5% 1/4W	
	R 326	QRE141J-361Y	C RESISTOR	360 5% 1/4W		△	R 821	QRJ146J-100X	UNF C RESISTOR	10 5% 1/4W	
	R 327	QRE141J-471Y	C RESISTOR	470 5% 1/4W		△	R 822	QRJ146J-100X	UNF C RESISTOR	10 5% 1/4W	
	R 328	QRE141J-471Y	C RESISTOR	470 5% 1/4W		△	R 823	QRJ146J-100X	UNF C RESISTOR	10 5% 1/4W	
	R 329	QRE141J-471Y	C RESISTOR	470 5% 1/4W		△	R 824	QRJ146J-100X	UNF C RESISTOR	10 5% 1/4W	
	R 330	QRE141J-471Y	C RESISTOR	470 5% 1/4W			R 825	QRE141J-361Y	C RESISTOR	360 5% 1/4W	
△	R 331	QRJ146J-100X	UNF C RESISTOR	10 5% 1/4W			R 826	QRE141J-361Y	C RESISTOR	360 5% 1/4W	
△	R 332	QRJ146J-100X	UNF C RESISTOR	10 5% 1/4W			R 827	QRE141J-911Y	C RESISTOR	910 5% 1/4W	
△	R 333	QRJ146J-100X	UNF C RESISTOR	10 5% 1/4W			R 828	QRE141J-911Y	C RESISTOR	910 5% 1/4W	
△	R 334	QRJ146J-100X	UNF C RESISTOR	10 5% 1/4W			R 829	QRE141J-471Y	C RESISTOR	470 5% 1/4W	
	R 335	QRE141J-121Y	C RESISTOR	120 5% 1/4W			R 830	QRE141J-471Y	C RESISTOR	470 5% 1/4W	
	R 336	QRE141J-121Y	C RESISTOR	120 5% 1/4W		△	R 831	QRJ146J-100X	UNF C RESISTOR	10 5% 1/4W	
	R 337	QRE141J-121Y	C RESISTOR	120 5% 1/4W		△	R 832	QRJ146J-100X	UNF C RESISTOR	10 5% 1/4W	
	R 338	QRE141J-121Y	C RESISTOR	120 5% 1/4W		△	R 833	QRJ146J-100X	UNF C RESISTOR	10 5% 1/4W	
	R 339	QRE141J-181Y	C RESISTOR	180 5% 1/4W		△	R 834	QRJ146J-100X	UNF C RESISTOR	10 5% 1/4W	
	R 340	QRE141J-181Y	C RESISTOR	180 5% 1/4W			R 835	QRE141J-181Y	C RESISTOR	180 5% 1/4W	
	R 341	QRE141J-181Y	C RESISTOR	180 5% 1/4W			R 836	QRE141J-181Y	C RESISTOR	180 5% 1/4W	
	R 342	QRE141J-181Y	C RESISTOR	180 5% 1/4W			R 837	QRE141J-181Y	C RESISTOR	180 5% 1/4W	
△	R 343	QRZ0218-R22	EMIT RESISTOR	1/2W			R 838	QRE141J-181Y	C RESISTOR	180 5% 1/4W	
△	R 344	QRZ0218-R22	EMIT RESISTOR	1/2W			R 839	QRE141J-181Y	C RESISTOR	180 5% 1/4W	
	R 345	QRE141J-102Y	C RESISTOR	1.0K 5% 1/4W			R 840	QRE141J-181Y	C RESISTOR	180 5% 1/4W	
	R 346	QRE141J-102Y	C RESISTOR	1.0K 5% 1/4W			R 841	QRE141J-181Y	C RESISTOR	180 5% 1/4W	
	R 347	QRE141J-153Y	C RESISTOR	15K 5% 1/4W			R 842	QRE141J-181Y	C RESISTOR	180 5% 1/4W	
	R 348	QRE141J-153Y	C RESISTOR	15K 5% 1/4W		△	R 843	QRZ0218-R22	EMIT RESISTOR	1/2W	
	R 349	QRE141J-473Y	C RESISTOR	47K 5% 1/4W		△	R 844	QRZ0218-R22	EMIT RESISTOR	1/2W	
	R 350	QRE141J-473Y	C RESISTOR	47K 5% 1/4W			R 845	QRE141J-102Y	C RESISTOR	1.0K 5% 1/4W	
△	R 351	QRJ125J-330	UNF C RESISTOR	33 5% 1/2W			R 846	QRE141J-102Y	C RESISTOR	1.0K 5% 1/4W	
△	R 352	QRJ125J-330	UNF C RESISTOR	33 5% 1/2W			R 847	QRE141J-183Y	C RESISTOR	18K 5% 1/4W	
△	R 353	QRL022J-100	UNF OMF RESISTOR	10 5% 1/2W			R 848	QRE141J-183Y	C RESISTOR	18K 5% 1/4W	
△	R 354	QRL022J-100	UNF OMF RESISTOR	10 5% 1/2W			R 849	QRE141J-123Y	C RESISTOR	12K 5% 1/4W	
	R 501	QRE141J-331Y	C RESISTOR	330 5% 1/4W			R 850	QRE141J-123Y	C RESISTOR	12K 5% 1/4W	
	R 502	QRE141J-750Y	C RESISTOR	75 5% 1/4W		△	R 851	QRJ125J-330	UNF C RESISTOR	33 5% 1/2W	
	R 503	QRE141J-331Y	C RESISTOR	330 5% 1/4W		△	R 852	QRJ125J-330	UNF C RESISTOR	33 5% 1/2W	
	R 504	QRE141J-750Y	C RESISTOR	75 5% 1/4W		△	R 853	QRL022J-100	UNF OMF RESISTOR	10 5% 1/2W	
	R 505	QRE141J-750Y	C RESISTOR	75 5% 1/4W		△	R 854	QRL022J-100	UNF OMF RESISTOR	10 5% 1/2W	
	R 506	QRE141J-473Y	C RESISTOR	47K 5% 1/4W			R 855	QRE141J-332Y	C RESISTOR	3.3K 5% 1/4W	
	R 507	QRE141J-331Y	C RESISTOR	330 5% 1/4W			R 856	QRE141J-332Y	C RESISTOR	3.3K 5% 1/4W	
	R 508	QRE141J-750Y	C RESISTOR	75 5% 1/4W			R 857	QRE141J-332Y	C RESISTOR	3.3K 5% 1/4W	
	R 509	QRE141J-750Y	C RESISTOR	75 5% 1/4W			R 858	QRE141J-332Y	C RESISTOR	3.3K 5% 1/4W	
	R 510	QRE141J-473Y	C RESISTOR	47K 5% 1/4W			R 859	QRE141J-332Y	C RESISTOR	3.3K 5% 1/4W	
	R 511	QRE141J-151Y	C RESISTOR	150 5% 1/4W			R 860	QRE141J-332Y	C RESISTOR	3.3K 5% 1/4W	
	R 512	QRE141J-271Y	C RESISTOR	270 5% 1/4W			R 861	QRE141J-332Y	C RESISTOR	3.3K 5% 1/4W	
	R 513	QRE141J-152Y	C RESISTOR	1.5K 5% 1/4W			R 862	QRE141J-332Y	C RESISTOR	3.3K 5% 1/4W	
	R 514	QRE141J-151Y	C RESISTOR	150 5% 1/4W			R 901	QRE141J-222Y	C RESISTOR	2.2K 5% 1/4W	
	R 515	QRE141J-271Y	C RESISTOR	270 5% 1/4W			R 903	QRE141J-563Y	C RESISTOR	56K 5% 1/4W	
	R 516	QRE141J-152Y	C RESISTOR	1.5K 5% 1/4W			R 905	QRE141J-183Y	C RESISTOR	18K 5% 1/4W	
	R 521	QRE141J-221Y	C RESISTOR	220 5% 1/4W			R 907	QRE141J-302Y	C RESISTOR	3.0K 5% 1/4W	
	R 522	QRE141J-471Y	C RESISTOR	470 5% 1/4W			R 909	QRE141J-101Y	C RESISTOR	100 5% 1/4W	
	R 801	QRE141J-222Y	C RESISTOR	2.2K 5% 1/4W		△	R 911	QRJ146J-301X	UNF C RESISTOR	300 5% 1/4W	
	R 802	QRE141J-222Y	C RESISTOR	2.2K 5% 1/4W			R 913	QRE141J-563Y	C RESISTOR	56K 5% 1/4W	

■ Electrical parts list (Power amp board)

Block No. 01

△	Item	Parts number	Parts name	Remarks	Area
△	R 915	QRJ146J-331X	UNF C RESISTOR	330 5% 1/4W	
△	R 921	QRJ146J-100X	UNF C RESISTOR	10 5% 1/4W	
△	R 923	QRJ146J-100X	UNF C RESISTOR	10 5% 1/4W	
	R 925	QRE141J-361Y	C RESISTOR	360 5% 1/4W	
	R 927	QRE141J-911Y	C RESISTOR	910 5% 1/4W	
	R 929	QRE141J-471Y	C RESISTOR	470 5% 1/4W	
△	R 931	QRJ146J-100X	UNF C RESISTOR	10 5% 1/4W	
△	R 933	QRJ146J-100X	UNF C RESISTOR	10 5% 1/4W	
	R 935	QRE141J-181Y	C RESISTOR	180 5% 1/4W	
	R 937	QRE141J-181Y	C RESISTOR	180 5% 1/4W	
	R 939	QRE141J-181Y	C RESISTOR	180 5% 1/4W	
	R 941	QRE141J-181Y	C RESISTOR	180 5% 1/4W	
△	R 943	QRZ0218-R22	EMIT RESISTOR	1/2W	
	R 945	QRE141J-102Y	C RESISTOR	1.0K 5% 1/4W	
	R 947	QRE141J-183Y	C RESISTOR	18K 5% 1/4W	
	R 949	QRE141J-473Y	C RESISTOR	47K 5% 1/4W	
△	R 951	QRJ125J-330	UNF C RESISTOR	33 5% 1/2W	
△	R 953	QRL022J-100	UNF OMF RESISTOR	10 5% 1/2W	
	R 955	QRE141J-332Y	C RESISTOR	3.3K 5% 1/4W	
	R 957	QRE141J-332Y	C RESISTOR	3.3K 5% 1/4W	
	R 959	QRE141J-332Y	C RESISTOR	3.3K 5% 1/4W	
	R 961	QRE141J-332Y	C RESISTOR	3.3K 5% 1/4W	
△	RY202	QSK0098-001	RELAY		
△	RY203	QSK0109-001	RELAY		
△	R1331	QRL022J-471	UNF OMF RESISTOR	470 5% 1/2W	
△	R1332	QRL022J-471	UNF OMF RESISTOR	470 5% 1/2W	
△	T 202	QQT0281-002	POWER TRANSF		
	TA201	QNZ0079-001Z	TAB		
	TA202	QNZ0079-001Z	TAB		
△	TH301	QAD0012-202	THERMISTOR		
△	TH302	QAD0012-202	THERMISTOR		
△	TH801	QAD0012-202	THERMISTOR		
△	TH802	QAD0012-202	THERMISTOR		
△	TH901	QAD0012-202	THERMISTOR		
	VR301	QVP0008-102Z	SEMI V RESISTOR		
	VR302	QVP0008-102Z	SEMI V RESISTOR		

■ Electrical parts list (Main board)

Block No. 02

▲	Item	Parts number	Parts name	Remarks	Area	▲	Item	Parts number	Parts name	Remarks	Area
	C 400	QCBB1HK-223Y	C CAPACITOR	.022MF 10% 50V			C1301	QFZ9076-104Z	MM CAPACITOR	.10MF	
	C 401	QETN1HM-475Z	E CAPACITOR	4.7MF 20% 50V			C1302	QCE22HP-103	C CAPACITOR	.010MF +100-0%	
	C 402	QETN1HM-475Z	E CAPACITOR	4.7MF 20% 50V			C1303	QCE22HP-103	C CAPACITOR	.010MF +100-0%	
	C 403	QCBB1HK-101Y	C CAPACITOR	100PF 10% 50V			C1304	QEZ0341-688	E CAPACITER	6800MF	
	C 404	QCBB1HK-101Y	C CAPACITOR	100PF 10% 50V			C1305	QEZ0341-688	E CAPACITER	6800MF	
	C 405	QETN1AM-107Z	E CAPACITOR	100MF 20% 10V			C1306	QETN1EM-476Z	E CAPACITOR	47MF 20% 25V	
	C 406	QETN1AM-107Z	E CAPACITOR	100MF 20% 10V			C1308	QETN1HM-476Z	E CAPACITOR	47MF 20% 50V	
	C 407	QCS31HJ-101Z	C CAPACITOR	100PF 5% 50V			C1309	QETN1HM-106Z	E CAPACITOR	10MF 20% 50V	
	C 408	QCS31HJ-101Z	C CAPACITOR	100PF 5% 50V			C1310	QETN1CM-476Z	E CAPACITOR	47MF 20% 16V	
	C 409	QFLC1HJ-182Z	M CAPACITOR	1800PF 5% 50V			C1311	QEK1HM-226Z	E CAPACITOR	220PF 5% 50V	
	C 410	QFLC1HJ-182Z	M CAPACITOR	1800PF 5% 50V			C1351	QETN1HM-475Z	E CAPACITOR	4.7MF 20% 50V	
	C 411	QFLC1HJ-682Z	M CAPACITOR	6800PF 5% 50V			C1352	QETN1HM-475Z	E CAPACITOR	4.7MF 20% 50V	
	C 412	QFLC1HJ-682Z	M CAPACITOR	6800PF 5% 50V			C1353	QEK1HM-475Z	E CAPACITOR	4.7MF 20% 50V	
	C 413	QETN1HM-475Z	E CAPACITOR	4.7MF 20% 50V			C1354	QETN1HM-475Z	E CAPACITOR	4.7MF 20% 50V	
	C 414	QETN1HM-475Z	E CAPACITOR	4.7MF 20% 50V			C1355	QFLC1HJ-223Z	M CAPACITOR	.022MF 5% 50V	
	C 415	QETN1CM-476Z	E CAPACITOR	47MF 20% 16V			C1356	QCS31HJ-221Z	C CAPACITOR	220PF 5% 50V	
	C 416	QETN1CM-476Z	E CAPACITOR	47MF 20% 16V			C1357	QFLC1HJ-223Z	M CAPACITOR	.022MF 5% 50V	
	C 417	QCBB1HK-331Y	C CAPACITOR	330PF 10% 50V			C1358	QCS31HJ-221Z	C CAPACITOR	220PF 5% 50V	
	C 418	QCBB1HK-331Y	C CAPACITOR	330PF 10% 50V			C1359	QFLC1HJ-103Z	M CAPACITOR	.010MF 5% 50V	
	C 419	QCBB1HK-223Y	C CAPACITOR	.022MF 10% 50V			C1360	QFLC1HJ-103Z	M CAPACITOR	.010MF 5% 50V	
	C 420	QCBB1HK-223Y	C CAPACITOR	.022MF 10% 50V			C1361	QFLC1HJ-223Z	M CAPACITOR	.022MF 5% 50V	
	C 421	QCBB1HK-331Y	C CAPACITOR	330PF 10% 50V			C1362	QCS31HJ-221Z	C CAPACITOR	220PF 5% 50V	
	C 422	QCBB1HK-331Y	C CAPACITOR	330PF 10% 50V			C1363	QFLC1HJ-223Z	M CAPACITOR	.022MF 5% 50V	
	C 427	QCBB1HK-681Y	C CAPACITOR	680PF 10% 50V			C1364	QCS31HJ-221Z	C CAPACITOR	220PF 5% 50V	
	C 428	QCBB1HK-681Y	C CAPACITOR	680PF 10% 50V			C1365	QFLC1HJ-473Z	M CAPACITOR	.047MF 5% 50V	
	C 433	QCBB1HK-681Y	C CAPACITOR	680PF 10% 50V			C1366	QCS31HJ-221Z	C CAPACITOR	220PF 5% 50V	
	C 434	QCBB1HK-681Y	C CAPACITOR	680PF 10% 50V			C1367	QCBB1HK-221Y	C CAPACITOR	220PF 10% 50V	
	C 440	QCBB1HK-221Y	C CAPACITOR	220PF 10% 50V			C1368	QFLC1HJ-102Z	M CAPACITOR	1000PF 5% 50V	
	C 441	QETN1HM-475Z	E CAPACITOR	4.7MF 20% 50V			C1369	QFLC1HJ-223Z	M CAPACITOR	.022MF 5% 50V	
	C 442	QETN1HM-475Z	E CAPACITOR	4.7MF 20% 50V			C1370	QCS31HJ-221Z	C CAPACITOR	220PF 5% 50V	
	C 443	QETN1HM-475Z	E CAPACITOR	4.7MF 20% 50V			C1371	QCBB1HK-221Y	C CAPACITOR	220PF 10% 50V	
	C 444	QETN1HM-475Z	E CAPACITOR	4.7MF 20% 50V			C1372	QCS31HJ-221Z	C CAPACITOR	220PF 5% 50V	
	C 445	QCBB1HK-223Y	C CAPACITOR	.022MF 10% 50V			C1373	QFLC1HJ-223Z	M CAPACITOR	.022MF 5% 50V	
	C 446	QCBB1HK-223Y	C CAPACITOR	.022MF 10% 50V			C1374	QCS31HJ-221Z	C CAPACITOR	220PF 5% 50V	
	C 551	QDX31EM-473Z	C CAPACITOR				C1375	QCS31HJ-221Z	C CAPACITOR	220PF 5% 50V	
	C 552	QETN1HM-475Z	E CAPACITOR	4.7MF 20% 50V			C1376	QCBB1HK-221Y	C CAPACITOR	220PF 10% 50V	
	C 553	QDX31EM-473Z	C CAPACITOR				C1377	QFLC1HJ-103Z	M CAPACITOR	.010MF 5% 50V	
	C 554	QETN1HM-475Z	E CAPACITOR	4.7MF 20% 50V			C1378	QFLC1HJ-103Z	M CAPACITOR	.010MF 5% 50V	
	C 555	QDX31EM-473Z	C CAPACITOR			▲	D1301	30DF2-FC	DIODE		
	C 556	QETN0JM-477Z	E CAPACITOR	470MF 20% 6.3V		▲	D1302	30DF2-FC	DIODE		
	C 557	QCS31HJ-470Z	C CAPACITOR	47PF 5% 50V		▲	D1303	30DF2-FC	DIODE		
	C 558	QCS31HJ-470Z	C CAPACITOR	47PF 5% 50V		▲	D1304	30DF2-FC	DIODE		
	C 559	QDX31EM-473Z	C CAPACITOR				D1305	MTZJ22C-T2	Z DIODE		
	C 560	QETN1HM-475Z	E CAPACITOR	4.7MF 20% 50V			D1306	MTZJ30C-T2	Z DIODE		
	C 561	QDX31EM-473Z	C CAPACITOR				D1307	1SS133-T2	SI DIODE		
	C 562	QETN0JM-477Z	E CAPACITOR	470MF 20% 6.3V			D1308	1SS133-T2	SI DIODE		
	C 563	QCS31HJ-470Z	C CAPACITOR	47PF 5% 50V			D1309	MTZJ20C-T2	Z DIODE		
	C 564	QCS31HJ-470Z	C CAPACITOR	47PF 5% 50V			D1351	1SS133-T2	SI DIODE		
	C 581	QETN1CM-476Z	E CAPACITOR	47MF 20% 16V			D1352	1SS133-T2	SI DIODE		
	C 582	QCZ0205-155Z	ML C CAPACITOR	1.5MF			D1353	1SS133-T2	SI DIODE		
	C 583	QETN1CM-476Z	E CAPACITOR	47MF 20% 16V			D1354	1SS133-T2	SI DIODE		
	C 584	QCZ0205-155Z	ML C CAPACITOR	1.5MF			D1355	1SS133-T2	SI DIODE		
	CN311	QGB2510J1-14	CONNECTOR				D1356	MTZJ5.1C-T2	Z DIODE		
	CN312	QGB2510J1-14	CONNECTOR				D1357	1SS133-T2	SI DIODE		
	CN321	QGB2510J1-14	CONNECTOR				D1358	1SS133-T2	SI DIODE		
	CN331	QGB2510J1-14	CONNECTOR				D1359	1SS133-T2	SI DIODE		
	CN332	QGB2510J1-14	CONNECTOR				D1360	1SS133-T2	SI DIODE		
	CN351	QJK012-032403	SKT WIRE ASSY				EP301	QNZ0136-001Z	EARTH PLATE		
	CN371	QJP001-031201	SHI CR C-B WIRE				FW301	QUM135-25Z4Z4	PARA RIBON WIRE		
	CN372	QJP002-021201	SHI CR C-B WIRE				FW302	QUM136-25Z4Z4	PARA RIBON WIRE		
	CN373	QJP001-031201	SHI CR C-B WIRE				FW303	QUM135-28DGZ4	PARA RIBON WIRE		
	CN401	QGB2510K1-14	CONNECTOR				FW341	QUM135-20DGZ4	SOCKET		
	CN551	QGB2510K1-07	CONNECTOR				IC401	NUM4580D-D	IC		

■ Electrical parts list (Main board)

Block No. 02

△	Item	Parts number	Parts name	Remarks	Area	△	Item	Parts number	Parts name	Remarks	Area
	IC402	TC9164AN	IC				R 441	QRE141J-104Y	C RESISTOR	100K 5% 1/4W	
	IC403	BA15218N	IC				R 442	QRE141J-104Y	C RESISTOR	100K 5% 1/4W	
	IC551	NJM2246D	IC				R 443	QRE141J-104Y	C RESISTOR	100K 5% 1/4W	
	IC552	NJM2246D	IC				R 444	QRE141J-104Y	C RESISTOR	100K 5% 1/4W	
	J 401	QNN0389-001	PIN JACK	PHONO			R 445	QRE141J-104Y	C RESISTOR	100K 5% 1/4W	
	J 402	QNN0168-001	PIN JACK				R 446	QRE141J-104Y	C RESISTOR	100K 5% 1/4W	
	J 403	QNN0168-001	PIN JACK				△ R 449	QRJ146J-271X	UNF C RESISTOR	270 5% 1/4W	
	J 551	QND0083-001	S JACK			△ R 450	QRJ146J-271X	UNF C RESISTOR	270 5% 1/4W		
	J 552	QND0083-001	S JACK				R 551	QRE141J-750Y	C RESISTOR	75 5% 1/4W	
	J 553	QND0025-001	S JACK	DBS			R 552	QRE141J-750Y	C RESISTOR	75 5% 1/4W	
	K 551	QQR0621-001Z	FERRITE BEADS				R 553	QRE141J-750Y	C RESISTOR	75 5% 1/4W	
	K 552	QQR0621-001Z	FERRITE BEADS				R 554	QRE141J-750Y	C RESISTOR	75 5% 1/4W	
	L1351	QQLZ005-R45	INDUCTOR				R 555	QRE141J-750Y	C RESISTOR	75 5% 1/4W	
	L1352	QQLZ005-R45	INDUCTOR				R 556	QRE141J-750Y	C RESISTOR	75 5% 1/4W	
	L1353	QQLZ005-R45	INDUCTOR				R 557	QRE141J-473Y	C RESISTOR	47K 5% 1/4W	
	L1354	QQLZ005-R45	INDUCTOR				R 558	QRE141J-473Y	C RESISTOR	47K 5% 1/4W	
	L1355	QQLZ005-R45	INDUCTOR				R 559	QRE141J-750Y	C RESISTOR	75 5% 1/4W	
	Q 553	KTA1267/YG/-T	TRANSISTOR				R 560	QRE141J-750Y	C RESISTOR	75 5% 1/4W	
	Q 554	KTA1267/YG/-T	TRANSISTOR				R 561	QRE141J-750Y	C RESISTOR	75 5% 1/4W	
	Q 571	KTA1267/YG/-T	TRANSISTOR				R 562	QRE141J-750Y	C RESISTOR	75 5% 1/4W	
	Q 572	KTA1267/YG/-T	TRANSISTOR				R 563	QRE141J-473Y	C RESISTOR	47K 5% 1/4W	
	Q 573	KRC110M-T	TRANSISTOR				R 564	QRE141J-473Y	C RESISTOR	47K 5% 1/4W	
	Q 574	KRC110M-T	TRANSISTOR				R 565	QRE141J-391Y	C RESISTOR	390 5% 1/4W	
△	Q1301	KTA1046/Y/	TRANSISTOR				R 566	QRE141J-391Y	C RESISTOR	390 5% 1/4W	
	Q1302	KTC3200/GL/-T	TRANSISTOR				R 571	QRE141J-391Y	C RESISTOR	390 5% 1/4W	
	Q1303	KTA1268/GL/-T	TRANSISTOR				R 572	QRE141J-391Y	C RESISTOR	390 5% 1/4W	
	Q1304	KTC3199/GL/-T	TRANSISTOR				R 573	QRE141J-103Y	C RESISTOR	10K 5% 1/4W	
	Q1305	2SD2395/EF/	TRANSISTOR				R 574	QRE141J-103Y	C RESISTOR	10K 5% 1/4W	
	Q1306	KTA1023/OY/-T	TRANSISTOR			△	R 581	QRJ146J-6R8X	UNF C RESISTOR	6.8 5% 1/4W	
	Q1307	KTC3200/GL/-T	TRANSISTOR			△	RY301	QSK0109-001	RELAY		
	Q1351	KRC109M-T	D TRANSISTOR			△	RY302	QSK0109-001	RELAY		
	Q1352	KRC109M-T	D TRANSISTOR			△	RY303	QSK0109-001	RELAY		
	Q1353	KRC109M-T	D TRANSISTOR			△	RY304	QSK0109-001	RELAY		
	Q1354	KRC109M-T	D TRANSISTOR			△	R1301	QRL022J-562	UNF OMF RESISTOR	5.6K 5% 1/2W	
	Q1355	KRC109M-T	D TRANSISTOR			△	R1302	QRZ9005-100X	F RESISTOR	10 1/0W	
	Q1356	KRC109M-T	D TRANSISTOR			△	R1303	QRJ146J-562X	UNF C RESISTOR	5.6K 5% 1/4W	
	Q1357	KRC109M-T	D TRANSISTOR				R1304	QRE141J-104Y	C RESISTOR	100K 5% 1/4W	
	Q1358	KRC109M-T	D TRANSISTOR				R1305	QRE141J-104Y	C RESISTOR	100K 5% 1/4W	
	R 401	QRE141J-222Y	C RESISTOR	2.2K 5% 1/4W			R1306	QRE141J-823Y	C RESISTOR	82K 5% 1/4W	
	R 402	QRE141J-222Y	C RESISTOR	2.2K 5% 1/4W			R1307	QRE141J-104Y	C RESISTOR	100K 5% 1/4W	
	R 403	QRE141J-473Y	C RESISTOR	47K 5% 1/4W			R1308	QRE141J-104Y	C RESISTOR	100K 5% 1/4W	
	R 404	QRE141J-473Y	C RESISTOR	47K 5% 1/4W			R1309	QRE141J-103Y	C RESISTOR	10K 5% 1/4W	
	R 405	QRE141J-561Y	C RESISTOR	560 5% 1/4W			R1310	QRE141J-103Y	C RESISTOR	10K 5% 1/4W	
	R 406	QRE141J-561Y	C RESISTOR	560 5% 1/4W			R1311	QRE141J-104Y	C RESISTOR	100K 5% 1/4W	
	R 407	QRE141J-393Y	C RESISTOR	39K 5% 1/4W			R1312	QRE141J-104Y	C RESISTOR	100K 5% 1/4W	
	R 408	QRE141J-393Y	C RESISTOR	39K 5% 1/4W		△	R1313	QRZ9005-100X	F RESISTOR	10 1/0W	
	R 409	QRE141J-474Y	C RESISTOR	470K 5% 1/4W		△	R1314	QRJ146J-103X	UNF C RESISTOR	10K 5% 1/4W	
	R 410	QRE141J-474Y	C RESISTOR	470K 5% 1/4W		△	R1315	QRJ146J-2R2X	UNF C RESISTOR	2.2 5% 1/4W	
	R 411	QRE141J-104Y	C RESISTOR	100K 5% 1/4W		△	R1316	QRJ146J-102X	UNF C RESISTOR	1.0K 5% 1/4W	
	R 412	QRE141J-104Y	C RESISTOR	100K 5% 1/4W		△	R1317	QRJ146J-223X	UNF C RESISTOR	22K 5% 1/4W	
	R 421	QRE141J-471Y	C RESISTOR	470 5% 1/4W			R1318	QRE141J-223Y	C RESISTOR	22K 5% 1/4W	
	R 422	QRE141J-471Y	C RESISTOR	470 5% 1/4W			R1319	QRE141J-473Y	C RESISTOR	47K 5% 1/4W	
	R 423	QRE141J-222Y	C RESISTOR	2.2K 5% 1/4W		△	R1351	QRJ146J-680X	UNF C RESISTOR	68 5% 1/4W	
	R 424	QRE141J-222Y	C RESISTOR	2.2K 5% 1/4W		△	R1352	QRJ146J-680X	UNF C RESISTOR	68 5% 1/4W	
	R 425	QRE141J-471Y	C RESISTOR	470 5% 1/4W		△	R1353	QRJ146J-680X	UNF C RESISTOR	68 5% 1/4W	
	R 426	QRE141J-471Y	C RESISTOR	470 5% 1/4W		△	R1354	QRJ146J-680X	UNF C RESISTOR	68 5% 1/4W	
	R 429	QRE141J-102Y	C RESISTOR	1.0K 5% 1/4W		△	R1355	QRJ146J-392X	UNF C RESISTOR	3.9K 5% 1/4W	
	R 430	QRE141J-102Y	C RESISTOR	1.0K 5% 1/4W			R1356	QRE141J-472Y	C RESISTOR	4.7K 5% 1/4W	
	R 431	QRE141J-471Y	C RESISTOR	470 5% 1/4W			R1357	QRE141J-223Y	C RESISTOR	22K 5% 1/4W	
	R 432	QRE141J-471Y	C RESISTOR	470 5% 1/4W			R1358	QRE141J-682Y	C RESISTOR	6.8K 5% 1/4W	
	R 435	QRE141J-102Y	C RESISTOR	1.0K 5% 1/4W			R1359	QRE141J-472Y	C RESISTOR	4.7K 5% 1/4W	
	R 436	QRE141J-102Y	C RESISTOR	1.0K 5% 1/4W			R1360	QRE141J-472Y	C RESISTOR	4.7K 5% 1/4W	
	R 440	QRE141J-102Y	C RESISTOR	1.0K 5% 1/4W			R1361	QRE141J-472Y	C RESISTOR	4.7K 5% 1/4W	

■ Electrical parts list (Main board)

Block No. 02

△	Item	Parts number	Parts name	Remarks	Area
	R1362	QRE141J-472Y	C RESISTOR	4.7K 5% 1/4W	
	R1363	QRE141J-472Y	C RESISTOR	4.7K 5% 1/4W	
	R1364	QRE141J-223Y	C RESISTOR	22K 5% 1/4W	
	R1365	QRE141J-682Y	C RESISTOR	6.8K 5% 1/4W	
	R1366	QRE141J-223Y	C RESISTOR	22K 5% 1/4W	
	R1367	QRE141J-682Y	C RESISTOR	6.8K 5% 1/4W	
△	R1368	QRJ146J-2R7X	UNF C RESISTOR	2.7 5% 1/4W	
△	R1369	QRJ146J-2R7X	UNF C RESISTOR	2.7 5% 1/4W	
△	R1370	QRJ146J-2R7X	UNF C RESISTOR	2.7 5% 1/4W	
△	R1371	QRJ146J-2R7X	UNF C RESISTOR	2.7 5% 1/4W	
△	R1372	QRJ146J-2R7X	UNF C RESISTOR	2.7 5% 1/4W	
△	R1373	QRJ146J-2R7X	UNF C RESISTOR	2.7 5% 1/4W	
△	R1374	QRJ146J-2R7X	UNF C RESISTOR	2.7 5% 1/4W	
	ST301	QNB0047-001	SPK TERMINAL	SPK1 FOR OTHER	
	ST302	QNB0001-002	SPK TERMINAL	SPK2	
	ST303	QNB0101-001	SPK TERMINAL	CNT/SR FOR OTHE	

■ Electrical parts list (System control & Audio board) Block No. 03

△	Item	Parts number	Parts name	Remarks	Area	△	Item	Parts number	Parts name	Remarks	Area
	BK701	LV42093-001A	FL HOLDER(L)				C1415	NCB31HK-101X	C CAPACITOR		
	BK702	LV42092-001A	FL HOLDER(R)				C1416	QETN1HM-474Z	E CAPACITOR	.47MF 20% 50V	
	C 451	NCB31HK-331X	C CAPACITOR				C1417	QETN1HM-474Z	E CAPACITOR	.47MF 20% 50V	
	C 452	NCB31HK-331X	C CAPACITOR				C1418	QFLC1HJ-223Z	M CAPACITOR	.022MF 5% 50V	
	C 453	NCB31HK-331X	C CAPACITOR				C1419	QFLC1HJ-223Z	M CAPACITOR	.022MF 5% 50V	
	C 454	NCB31HK-331X	C CAPACITOR				C1420	QEKC1HM-475Z	E CAPACITOR	4.7MF 20% 50V	
	C 455	NCB31HK-331X	C CAPACITOR				C1421	QEKC1HM-475Z	E CAPACITOR	4.7MF 20% 50V	
	C 456	NCB31HK-331X	C CAPACITOR				C1422	QETN1HM-475Z	E CAPACITOR	4.7MF 20% 50V	
	C 459	QFLC1HJ-104Z	M CAPACITOR	.10MF 5% 50V			C1423	QEKC1HM-475Z	E CAPACITOR	4.7MF 20% 50V	
	C 460	QCZ0202-155Z	ML C CAPACITOR	1.5MF			C1424	QEKC1HM-475Z	E CAPACITOR	4.7MF 20% 50V	
	C 701	QETN0JM-107Z	E CAPACITOR	100MF 20% 6.3V			C1425	QETN1AM-107Z	E CAPACITOR	100MF 20% 10V	
	C 702	QCZ0202-155Z	ML C CAPACITOR	1.5MF			C1426	NCB31CK-223X	C CAPACITOR		
	C 703	QETN1HM-225Z	E CAPACITOR	2.2MF 20% 50V			C1427	QFVF1HJ-334Z	MF CAPACITOR	.33MF 5% 50V	
	C 704	NCB31CK-223X	C CAPACITOR				C1428	QFLC1HJ-153Z	M CAPACITOR	.015MF 5% 50V	
	C 705	QETN0JM-107Z	E CAPACITOR	100MF 20% 6.3V			C1429	QCB31HK-822Z	C CAPACITOR	8200PF 10% 50V	
	C 706	NCB21HK-331X	C CAPACITOR				C1430	QETN1HM-475Z	E CAPACITOR	4.7MF 20% 50V	
	C 707	QETN1HM-475Z	E CAPACITOR	4.7MF 20% 50V			C1431	QETN1HM-475Z	E CAPACITOR	4.7MF 20% 50V	
	C 708	QETN1HM-475Z	E CAPACITOR	4.7MF 20% 50V			C1432	NCB31CK-223X	C CAPACITOR		
	C 709	QETN1HM-475Z	E CAPACITOR	4.7MF 20% 50V			C1433	QFVF1HJ-334Z	MF CAPACITOR	.33MF 5% 50V	
	C 713	NCB21HK-103X	C CAPACITOR				C1434	QFLC1HJ-153Z	M CAPACITOR	.015MF 5% 50V	
	C 714	NCB21HK-103X	C CAPACITOR				C1435	QCB31HK-822Z	C CAPACITOR	8200PF 10% 50V	
	C 715	NCB21HK-103X	C CAPACITOR				C1436	NCB31CK-223X	C CAPACITOR		
	C 716	NCB21HK-103X	C CAPACITOR				C1437	QCZ0202-155Z	ML C CAPACITOR	1.5MF	
	C 717	NCB21HK-103X	C CAPACITOR				C1438	QETN0JM-477Z	E CAPACITOR	470MF 20% 6.3V	
	C 718	NCB21HK-103X	C CAPACITOR				C1439	QFLC1HJ-562Z	M CAPACITOR	5600PF 5% 50V	
	C 719	NCB21HK-103X	C CAPACITOR				C1440	QFLC1HJ-562Z	M CAPACITOR	5600PF 5% 50V	
	C 720	NCB31CK-104X	C CAPACITOR				C1443	QCZ0202-155Z	ML C CAPACITOR	1.5MF	
	C 721	NCB31CK-104X	C CAPACITOR				C1444	NCB31CK-223X	C CAPACITOR		
	C 722	QCZ0202-155Z	ML C CAPACITOR	1.5MF			C1445	NCB31CK-223X	C CAPACITOR		
	C 730	NCB31CK-104X	C CAPACITOR				C1446	NCB31HK-221X	C CAPACITOR		
	CN402	QGF1205C1-25	CONNECTOR				C1447	QETN1HM-475Z	E CAPACITOR	4.7MF 20% 50V	
	CN403	QGA2001C1-04	4P PLUG ASSY				C1453	QETN1HM-475Z	E CAPACITOR	4.7MF 20% 50V	
	CN411	QGB2501J1-12	CONNECTOR				C1459	QETN1HM-475Z	E CAPACITOR	4.7MF 20% 50V	
	CN412	QGB2501J1-04	CONNECTOR				D 701	1SS355-X	DIODE		
	CN421	QGB2510J1-14	CONNECTOR				D 702	1SS355-X	DIODE		
	CN431	QGB2510J1-11	CONNECTOR				D 719	SLR-342VC-T	LED		
	CN441	QGB2510J1-07	CONNECTOR				DI701	QLF0082-001	FL TUBE		
	CN451	QGB2510K1-11	CONNECTOR				D1401	MTZJ13C-T2	Z DIODE		
	CN461	QGB2510J1-07	CONNECTOR				D1402	MTZJ6.2C-T2	Z DIODE		
	CN471	QGA2501C1-03	3P CONNECTOR				D1403	MTZJ5.6C-T2	Z DIODE		
	CN472	QGA2501C1-02	2P CONNECTOR				D1404	MTZJ5.6C-T2	Z DIODE		
	CN473	QGA2501C1-03	3P CONNECTOR				D1405	MTZJ13C-T2	Z DIODE		
	CN481	QGB2510J1-20	CONNECTOR				D1406	MTZJ10C-T2	Z DIODE		
	CN491	QGB2510J1-04	CONNECTOR				D1407	MTZJ7.5C-T2	Z DIODE		
	CN701	QGF1205F1-14	CONNECTOR				D1408	MTZJ7.5C-T2	Z DIODE		
	CN702	QGF1205F1-25	CONNECTOR				D1409	1SS355-X	DIODE		
	CN703	WJS0021-001A	SIN CR C-B WIRE				D1410	1SS355-X	DIODE		
	CN704	WJS0020-001A	SKT WIRE ASSY				D1411	1SS355-X	DIODE		
	CN714	QGA2001C1-03	3P PLUG ASSY				D1412	1SS355-X	DIODE		
	C1401	QETN1HM-476Z	E CAPACITOR	47MF 20% 50V			D1413	1SR35-400A-T5	DIODE		
	C1402	QETN1EM-107Z	E CAPACITOR	100MF 20% 25V			EP401	QNZ0136-001Z	EARTH PLATE		
	C1403	QETN1EM-107Z	E CAPACITOR	100MF 20% 25V			FL401	QQR0590-001	FILTER		
	C1404	QETN1EM-107Z	E CAPACITOR	100MF 20% 25V			FL402	QQR0590-001	FILTER		
	C1405	QETN1EM-107Z	E CAPACITOR	100MF 20% 25V			HS401	E70306-001	HEAT SINK		
	C1406	QETN1EM-107Z	E CAPACITOR	100MF 20% 25V			HS402	E70306-001	HEAT SINK		
	C1407	QCF31HZ-223Z	C CAPACITOR	.022MF +80%-20%			HS403	E70306-001	HEAT SINK		
	C1408	QETN1EM-476Z	E CAPACITOR	47MF 20% 25V			HS404	E70306-001	HEAT SINK		
	C1409	QETN1EM-476Z	E CAPACITOR	47MF 20% 25V			HS405	E70306-001	HEAT SINK		
	C1410	NCB31CK-223X	C CAPACITOR				HS434	E70306-001	HEAT SINK		
	C1411	NCB31CK-223X	C CAPACITOR				HS435	E70306-001	HEAT SINK		
	C1412	QETN1HM-475Z	E CAPACITOR	4.7MF 20% 50V			IC421	BA15218F-XE	IC		
	C1413	QETN1HM-475Z	E CAPACITOR	4.7MF 20% 50V			IC422	BA15218F-XE	IC		
	C1414	NCB31HK-101X	C CAPACITOR				IC423	TC9162AF-X	IC		

■ Electrical parts list (System control & Audio board) Block No. 03

△	Item	Parts number	Parts name	Remarks	Area	△	Item	Parts number	Parts name	Remarks	Area
	IC427	BA15218F-XE	IC				R 486	NRSA63J-104X	MG RESISTOR		
	IC428	M62446FP-X	IC				R 487	NRSA63J-102X	MG RESISTOR		
	IC701	MN101C35DHK1	IC				R 488	NRSA63J-104X	MG RESISTOR		
	IC702	IC-PST9139-T	IC				R 489	NRSA63J-562X	MG RESISTOR		
	IC703	GP1U281X	IC				R 490	NRSA63J-562X	MG RESISTOR		
	J 404	QNN0389-001	PIN JACK	DVD-FL/FR			R 491	NRSA63J-153X	MG RESISTOR		
	J 405	QNN0388-001	PIN JACK				R 492	NRSA63J-0R0X	MG RESISTOR		
	J 406	QNN0060-001	PIN JACK	SW OUT			R 493	NRSA63J-0R0X	MG RESISTOR		
	JS701	QSW0898-001	JOG VOLUME				R 494	NRSA63J-0R0X	MG RESISTOR		
	Q 701	DTC114YKA-X	D TRANSISTOR				R 495	NRSA63J-0R0X	MG RESISTOR		
	Q 702	DTC114TKA-X	TRANSISTOR				R 701	NRSA63J-472X	MG RESISTOR		
	Q 703	DTC144WKA-X	TRANSISTOR				R 702	NRSA63J-223X	MG RESISTOR		
	Q 704	DTC114YKA-X	D TRANSISTOR				R 703	NRSA63J-103X	MG RESISTOR		
	Q 707	DTC114YKA-X	D TRANSISTOR				R 704	NRSA63J-471X	MG RESISTOR		
	Q 708	DTC114YKA-X	D TRANSISTOR				R 705	NRSA63J-103X	MG RESISTOR		
	Q 709	DTC114YKA-X	D TRANSISTOR				R 706	NRSA63J-103X	MG RESISTOR		
	Q 711	DTA144EKA-X	TRANSISTOR				R 707	NRSA63J-103X	MG RESISTOR		
△	Q1401	KTA1046/Y/	TRANSISTOR				R 708	NRSA63J-103X	MG RESISTOR		
△	Q1402	2SD2395/EF/	TRANSISTOR				R 709	NRSA63J-103X	MG RESISTOR		
△	Q1403	2SD2395/EF/	TRANSISTOR				R 710	NRSA63J-103X	MG RESISTOR		
△	Q1404	2SD2395/EF/	TRANSISTOR				R 711	NRSA63J-104X	MG RESISTOR		
△	Q1405	2SD2395/EF/	TRANSISTOR				R 712	NRSA63J-103X	MG RESISTOR		
△	Q1406	KTC3203/OY/-T	TRANSISTOR				R 713	NRSA63J-103X	MG RESISTOR		
△	Q1407	KTC3203/OY/-T	TRANSISTOR				R 714	NRSA63J-103X	MG RESISTOR		
△	Q1408	KTA1271/OY/-T	TRANSISTOR				R 715	NRSA63J-103X	MG RESISTOR		
	Q1409	2SK301/PQ/-T	TRANSISTOR(FET)				R 716	NRSA63J-103X	MG RESISTOR		
	Q1410	2SK301/PQ/-T	TRANSISTOR(FET)				R 717	NRSA63J-103X	MG RESISTOR		
	Q1411	2SK301/PQ/-T	TRANSISTOR(FET)				R 718	NRSA63J-103X	MG RESISTOR		
	Q1412	2SK301/PQ/-T	TRANSISTOR(FET)				R 719	NRSA63J-221X	MG RESISTOR		
	Q1413	2SC3576-JVC-T	TRANSISTOR				R 720	NRSA63J-222X	MG RESISTOR		
	Q1414	2SC3576-JVC-T	TRANSISTOR				R 721	NRSA63J-103X	MG RESISTOR		
	Q1415	KRA104M-T	D TRANSISTOR				R 722	NRSA63J-102X	MG RESISTOR		
	Q1416	KRC104M-T	D TRANSISTOR				R 723	NRSA63J-102X	MG RESISTOR		
	Q1417	2SC3576-JVC-T	TRANSISTOR				R 724	NRSA63J-122X	MG RESISTOR		
	Q1418	2SC3576-JVC-T	TRANSISTOR				R 725	NRSA63J-152X	MG RESISTOR		
	Q1419	2SC3576-JVC-T	TRANSISTOR				R 726	NRSA63J-222X	MG RESISTOR		
	Q1420	KRA104M-T	D TRANSISTOR				R 727	NRSA63J-272X	MG RESISTOR		
	Q1421	2SC3576-JVC-T	TRANSISTOR				R 728	NRSA63J-103X	MG RESISTOR		
	Q1422	2SC3576-JVC-T	TRANSISTOR				R 729	NRSA63J-102X	MG RESISTOR		
	Q1423	KRA104M-T	D TRANSISTOR				R 730	NRSA63J-102X	MG RESISTOR		
	Q1424	KRA104M-T	D TRANSISTOR				R 731	NRSA63J-122X	MG RESISTOR		
	Q1425	2SC3576-JVC-T	TRANSISTOR				R 732	NRSA63J-152X	MG RESISTOR		
	Q1426	2SC3576-JVC-T	TRANSISTOR				R 733	NRSA63J-222X	MG RESISTOR		
	Q1431	KRC104M-T	D TRANSISTOR				R 734	NRSA63J-272X	MG RESISTOR		
	Q1432	KRC104M-T	D TRANSISTOR				R 735	NRSA63J-392X	MG RESISTOR		
	Q1433	KRC104M-T	D TRANSISTOR				R 736	NRSA63J-103X	MG RESISTOR		
△	Q1434	2SD2395/EF/	TRANSISTOR				R 737	NRSA63J-102X	MG RESISTOR		
△	Q1435	2SD2395/EF/	TRANSISTOR				R 738	NRSA63J-102X	MG RESISTOR		
	R 451	NRSA63J-471X	MG RESISTOR				R 739	NRSA63J-122X	MG RESISTOR		
	R 452	NRSA63J-471X	MG RESISTOR				R 740	NRSA63J-152X	MG RESISTOR		
	R 453	NRSA63J-471X	MG RESISTOR				R 741	NRSA63J-222X	MG RESISTOR		
	R 454	NRSA63J-471X	MG RESISTOR				R 742	NRSA63J-272X	MG RESISTOR		
	R 455	NRSA63J-471X	MG RESISTOR				R 743	NRSA63J-103X	MG RESISTOR		
	R 456	NRSA63J-471X	MG RESISTOR				R 744	NRSA63J-102X	MG RESISTOR		
	R 475	NRSA63J-203X	MG RESISTOR				R 745	NRSA63J-102X	MG RESISTOR		
	R 476	NRSA63J-273X	MG RESISTOR				R 746	NRSA63J-122X	MG RESISTOR		
△	R 477	QRZ9006-4R7X	F RESISTOR	4.7 1/0W			R 747	NRSA63J-152X	MG RESISTOR		
△	R 478	QRJ146J-2R2X	UNF C RESISTOR	2.2 5% 1/4W			R 748	NRSA63J-222X	MG RESISTOR		
△	R 479	QRJ146J-2R2X	UNF C RESISTOR	2.2 5% 1/4W			R 749	NRSA63J-272X	MG RESISTOR		
	R 480	NRSA63J-153X	MG RESISTOR				R 750	NRSA63J-103X	MG RESISTOR		
	R 483	NRSA63J-102X	MG RESISTOR				R 751	NRSA63J-102X	MG RESISTOR		
	R 484	NRSA63J-104X	MG RESISTOR				R 752	NRSA63J-102X	MG RESISTOR		
	R 485	NRSA63J-102X	MG RESISTOR				R 753	NRSA63J-122X	MG RESISTOR		

■ Electrical parts list (System control & Audio board) Block No. 03

△	Item	Parts number	Parts name	Remarks	Area	△	Item	Parts number	Parts name	Remarks	Area
	R 754	NRSA63J-152X	MG RESISTOR				R1432	NRSA63J-103X	MG RESISTOR		
	R 757	NRSA63J-103X	MG RESISTOR				R1433	NRSA63J-103X	MG RESISTOR		
	R 758	NRSA63J-103X	MG RESISTOR				R1434	NRSA63J-103X	MG RESISTOR		
	R 759	NRSA63J-103X	MG RESISTOR				R1435	NRSA63J-154X	MG RESISTOR		
	R 760	NRSA63J-103X	MG RESISTOR				R1436	NRSA63J-154X	MG RESISTOR		
	R 761	NRSA63J-103X	MG RESISTOR				R1437	NRSA63J-102X	MG RESISTOR		
	R 762	NRSA63J-102X	MG RESISTOR				R1438	NRSA63J-102X	MG RESISTOR		
	R 763	NRSA63J-102X	MG RESISTOR				R1439	NRSA63J-103X	MG RESISTOR		
	R 768	NRSA63J-103X	MG RESISTOR				R1440	NRSA63J-103X	MG RESISTOR		
	R 769	NRSA63J-102X	MG RESISTOR				R1441	NRSA63J-102X	MG RESISTOR		
	R 770	NRSA63J-102X	MG RESISTOR				R1442	NRSA63J-104X	MG RESISTOR		
	R 775	NRSA63J-103X	MG RESISTOR				R1443	NRSA63J-103X	MG RESISTOR		
	R 780	NRSA63J-221X	MG RESISTOR				R1444	NRSA63J-103X	MG RESISTOR		
	R 781	NRSA63J-221X	MG RESISTOR				R1445	NRSA63J-102X	MG RESISTOR		
	R 782	NRSA63J-221X	MG RESISTOR				R1446	NRSA63J-104X	MG RESISTOR		
	R 783	NRSA63J-221X	MG RESISTOR				R1447	NRSA63J-102X	MG RESISTOR		
	R 784	NRSA63J-221X	MG RESISTOR				R1448	NRSA63J-103X	MG RESISTOR		
	R 785	NRSA63J-221X	MG RESISTOR				R1449	NRSA63J-102X	MG RESISTOR		
	R 786	NRSA63J-221X	MG RESISTOR				R1450	NRSA63J-103X	MG RESISTOR		
	R 787	NRSA63J-221X	MG RESISTOR				R1451	NRSA63J-104X	MG RESISTOR		
	R 788	NRSA63J-221X	MG RESISTOR				R1452	NRSA63J-104X	MG RESISTOR		
	R 789	NRSA63J-221X	MG RESISTOR				R1453	NRSA63J-102X	MG RESISTOR		
	R 790	NRSA63J-221X	MG RESISTOR				R1455	NRSA63J-104X	MG RESISTOR		
	R 791	NRSA63J-221X	MG RESISTOR			△	R1456	QRJ146J-220X	UNF C RESISTOR	22 5% 1/4W	
	R 792	NRSA63J-221X	MG RESISTOR				R1457	NRSA63J-472X	MG RESISTOR		
	R 793	NRSA63J-221X	MG RESISTOR				R1458	NRSA63J-472X	MG RESISTOR		
	R 794	NRSA63J-221X	MG RESISTOR			△	R1459	QRZ9005-680X	F RESISTOR	68 1/0W	
	R 795	NRSA63J-221X	MG RESISTOR			△	R1460	QRZ9005-680X	F RESISTOR	68 1/0W	
	R 796	NRSA63J-221X	MG RESISTOR			△	R1461	QRJ146J-2R2X	UNF C RESISTOR	2.2 5% 1/4W	
	R 797	NRSA63J-221X	MG RESISTOR			△	R1462	QRJ146J-2R2X	UNF C RESISTOR	2.2 5% 1/4W	
	R 798	NRSA63J-221X	MG RESISTOR				R1463	NRSA63J-104X	MG RESISTOR		
	R 799	NRSA63J-221X	MG RESISTOR				R1464	NRSA63J-104X	MG RESISTOR		
△	R1401	QRZ9005-100X	F RESISTOR	10 1/0W			R1465	NRSA63J-102X	MG RESISTOR		
△	R1402	QRJ146J-182X	UNF C RESISTOR	1.8K 5% 1/4W			R1470	NRSA63J-391X	MG RESISTOR		
△	R1403	QRZ9005-120X	F RESISTOR	12 1/0W			R1471	NRSA63J-391X	MG RESISTOR		
△	R1404	QRJ146J-272X	UNF C RESISTOR	2.7K 5% 1/4W			R1472	NRSA63J-103X	MG RESISTOR		
△	R1405	QRZ9005-120X	F RESISTOR	12 1/0W			R1473	NRSA63J-103X	MG RESISTOR		
△	R1406	QRK126J-682X	UNF C RESISTOR	6.8K 5% 1/2W			R1474	NRSA63J-102X	MG RESISTOR		
△	R1407	QRZ9006-4R7X	F RESISTOR	4.7 1/0W			R1480	NRSA63J-104X	MG RESISTOR		
△	R1408	QRZ9006-4R7X	F RESISTOR	4.7 1/0W			R1490	NRSA63J-273X	MG RESISTOR		
△	R1409	QRJ146J-272X	UNF C RESISTOR	2.7K 5% 1/4W			R1492	NRSA63J-102X	MG RESISTOR		
△	R1410	QRZ9006-4R7X	F RESISTOR	4.7 1/0W			R1493	NRSA63J-102X	MG RESISTOR		
△	R1411	QRJ146J-182X	UNF C RESISTOR	1.8K 5% 1/4W			R1494	NRSA63J-102X	MG RESISTOR		
△	R1412	QRZ9005-100X	F RESISTOR	10 1/0W			R1495	NRSA63J-103X	MG RESISTOR		
△	R1413	QRJ146J-102X	UNF C RESISTOR	1.0K 5% 1/4W			R1496	NRSA63J-103X	MG RESISTOR		
△	R1414	QRZ9005-100X	F RESISTOR	10 1/0W			R1497	NRSA63J-511X	MG RESISTOR		
△	R1415	QRJ146J-222X	UNF C RESISTOR	2.2K 5% 1/4W			R1498	NRSA63J-511X	MG RESISTOR		
△	R1416	QRZ9005-100X	F RESISTOR	10 1/0W			R1499	NRSA63J-104X	MG RESISTOR		
△	R1417	QRJ146J-222X	UNF C RESISTOR	2.2K 5% 1/4W			S 721	QSW0683-001Z	PUSH SWITCH	TUNING+	
△	R1418	QRZ9005-680X	F RESISTOR	68 1/0W			S 722	QSW0683-001Z	PUSH SWITCH	TUNING-	
△	R1419	QRZ9005-680X	F RESISTOR	68 1/0W			S 723	QSW0683-001Z	PUSH SWITCH	PRESET+	
	R1420	NRSA63J-103X	MG RESISTOR				S 724	QSW0683-001Z	PUSH SWITCH	PRESET-	
	R1421	NRSA63J-272X	MG RESISTOR				S 725	QSW0683-001Z	PUSH SWITCH	FM MODE	
	R1422	NRSA63J-103X	MG RESISTOR				S 726	QSW0683-001Z	PUSH SWITCH	MEMORY	
	R1423	NRSA63J-272X	MG RESISTOR				S 727	QSW0683-001Z	PUSH SWITCH	POWER	
	R1424	NRSA63J-472X	MG RESISTOR				S 728	QSW0683-001Z	PUSH SWITCH	SURROUND	
	R1425	NRSA63J-472X	MG RESISTOR				S 729	QSW0683-001Z	PUSH SWITCH	DSP MODE	
	R1426	NRSA63J-513X	MG RESISTOR				S 730	QSW0683-001Z	PUSH SWITCH	ANA/DIG	
	R1427	NRSA63J-513X	MG RESISTOR				S 731	QSW0683-001Z	PUSH SWITCH	BASS BOOST	
	R1428	NRSA63J-103X	MG RESISTOR				S 732	QSW0683-001Z	PUSH SWITCH	SPK1	
	R1429	NRSA63J-103X	MG RESISTOR				S 733	QSW0683-001Z	PUSH SWITCH	SPK2	
	R1430	NRSA63J-103X	MG RESISTOR				S 734	QSW0683-001Z	PUSH SWITCH	DVD MULTI	
	R1431	NRSA63J-103X	MG RESISTOR				S 735	QSW0683-001Z	PUSH SWITCH	PHONO	

■ Electrical parts list (System control & Audio board) Block No. 03

△	Item	Parts number	Parts name	Remarks	Area
	S 736	QSW0683-001Z	PUSH SWITCH	DVD	
	S 737	QSW0683-001Z	PUSH SWITCH	CD	
	S 738	QSW0683-001Z	PUSH SWITCH	VCR	
	S 739	QSW0683-001Z	PUSH SWITCH	TAPE/CDR	
	S 740	QSW0683-001Z	PUSH SWITCH	TV/DBS	
	S 741	QSW0683-001Z	PUSH SWITCH	FM/AM	
	S 742	QSW0683-001Z	PUSH SWITCH	ADJUST	
	S 743	QSW0683-001Z	PUSH SWITCH	SETTING	
	S 744	QSW0683-001Z	PUSH SWITCH	+	
	S 745	QSW0683-001Z	PUSH SWITCH	-	
	S 746	QSW0683-001Z	PUSH SWITCH	EON	
	S 747	QSW0683-001Z	PUSH SWITCH	PTY	
	S 748	QSW0683-001Z	PUSH SWITCH	TA/NEWS/INFO	
	S 749	QSW0683-001Z	PUSH SWITCH	DISPLAY	
	X 701	QAX0246-001Z	RESONATOR		

■ Electrical parts list (DSP board)

Block No. 04

△	Item	Parts number	Parts name	Remarks	Area	△	Item	Parts number	Parts name	Remarks	Area
	C 601	NCB31HK-102X	C CAPACITOR				C2508	NCS31HJ-330X	C CAPACITOR		
	C 602	NCB31HK-102X	C CAPACITOR				C2512	NCF31CZ-104X	C CAPACITOR		
	C 603	QETN0JM-107Z	E CAPACITOR	100MF 20% 6.3V			C2513	NCB31HK-122X	C CAPACITOR		
	C 604	QETN0JM-107Z	E CAPACITOR	100MF 20% 6.3V			C2514	NCB31HK-122X	C CAPACITOR		
	C 605	NCF31CZ-104X	C CAPACITOR				C2515	NCS31HJ-121X	C CAPACITOR		
	C 606	NCF31CZ-104X	C CAPACITOR				C2516	NCS31HJ-121X	C CAPACITOR		
	C 607	QETN1CM-107Z	E CAPACITOR	100MF 20% 16V			C2517	NCS31HJ-391X	C CAPACITOR		
	C 608	NCF31CZ-104X	C CAPACITOR				C2518	NCS31HJ-391X	C CAPACITOR		
	C 609	NCF31CZ-104X	C CAPACITOR				C2525	NCB31HK-102X	C CAPACITOR		
	C 610	QETN0JM-107Z	E CAPACITOR	100MF 20% 6.3V			C2526	NCB31HK-102X	C CAPACITOR		
	C 611	QETN0JM-107Z	E CAPACITOR	100MF 20% 6.3V			C2527	QETN1HM-106Z	E CAPACITOR	10MF 20% 50V	
	C 612	NCB31CK-103X	C CAPACITOR				C2528	QETN1HM-106Z	E CAPACITOR	10MF 20% 50V	
	C 621	QETN1HM-105Z	E CAPACITOR	1.0MF 20% 50V			C2531	NCS31HJ-560X	C CAPACITOR		
	C 622	NCB31HK-101X	C CAPACITOR				C2532	NCS31HJ-560X	C CAPACITOR		
	C 624	NCF31CZ-104X	C CAPACITOR				C2533	QETN1HM-475Z	E CAPACITOR	4.7MF 20% 50V	
	C 625	NCF31CZ-104X	C CAPACITOR				C2534	QETN1HM-475Z	E CAPACITOR	4.7MF 20% 50V	
	C 626	NCB31CK-104X	C CAPACITOR				C2539	NCF31CZ-104X	C CAPACITOR		
	C 627	NCF31AZ-105X	C CAPACITOR				C2540	NCF31CZ-104X	C CAPACITOR		
	C 628	NCB31CK-103X	C CAPACITOR				C2551	NCS31HJ-560X	C CAPACITOR		
	C 629	NCF31CZ-104X	C CAPACITOR				C2552	NCS31HJ-560X	C CAPACITOR		
	C 631	QETN0JM-107Z	E CAPACITOR	100MF 20% 6.3V			C2555	NCF31CZ-104X	C CAPACITOR		
	C 632	NCB31CK-103X	C CAPACITOR				C2556	NCF31CZ-104X	C CAPACITOR		
	C 633	NCF31CZ-104X	C CAPACITOR				C2561	QETN1HM-105Z	E CAPACITOR	1.0MF 20% 50V	
	C 634	NCF31CZ-104X	C CAPACITOR				C2562	QETN1HM-105Z	E CAPACITOR	1.0MF 20% 50V	
	C 635	NCF31CZ-104X	C CAPACITOR				C2563	NCS31HJ-220X	C CAPACITOR		
	C 636	NCB31CK-473X	C CAPACITOR				C2564	NCS31HJ-220X	C CAPACITOR		
	C 637	NCF31CZ-104X	C CAPACITOR				C2569	NCF31CZ-104X	C CAPACITOR		
	C 638	QETN0JM-107Z	E CAPACITOR	100MF 20% 6.3V			C2570	NCF31CZ-104X	C CAPACITOR		
	C 639	NCB31CK-103X	C CAPACITOR				C2575	NCB31HK-102X	C CAPACITOR		
	C 641	QETN0JM-107Z	E CAPACITOR	100MF 20% 6.3V			C2576	NCB31HK-102X	C CAPACITOR		
	C 642	NCB31CK-103X	C CAPACITOR				C2577	QETN1HM-106Z	E CAPACITOR	10MF 20% 50V	
	C 643	NCB31AK-474X	C CAPACITOR				C2578	QETN1HM-106Z	E CAPACITOR	10MF 20% 50V	
	C 644	NCB31CK-103X	C CAPACITOR				C2581	QETN1HM-105Z	E CAPACITOR	1.0MF 20% 50V	
	C 645	NCS31HJ-101X	C CAPACITOR				C2582	QETN1CM-106Z	E CAPACITOR	10MF 20% 16V	
	C 646	NCB31CK-103X	C CAPACITOR				C2583	NCS31HJ-220X	C CAPACITOR		
	C 647	NCS31HJ-220X	C CAPACITOR				C2584	NCS31HJ-560X	C CAPACITOR		
	C 648	NCS31HJ-180X	C CAPACITOR				C2585	NCF31CZ-104X	C CAPACITOR		
	C 649	NCS31HJ-121X	C CAPACITOR				C2586	NCF31CZ-104X	C CAPACITOR		
	C 653	NCB31CK-104X	C CAPACITOR				C2587	NCS31HJ-560X	C CAPACITOR		
	C 654	QETN0JM-107Z	E CAPACITOR	100MF 20% 6.3V			C2588	QETN1HM-475Z	E CAPACITOR	4.7MF 20% 50V	
	C 661	NCB31CK-103X	C CAPACITOR				C2589	NCF31CZ-104X	C CAPACITOR		
	C 671	NCB31CK-103X	C CAPACITOR				C2590	NCF31CZ-104X	C CAPACITOR		
	C 672	QETN0JM-107Z	E CAPACITOR	100MF 20% 6.3V			C2592	NCB31HK-223X	C CAPACITOR		
	C 673	NCB31CK-103X	C CAPACITOR				C2594	NCF31CZ-104X	C CAPACITOR		
	C 677	NCB31HK-101X	C CAPACITOR				C2595	NCB31HK-102X	C CAPACITOR		
	C 679	NCB31HK-101X	C CAPACITOR				C2597	QETN1HM-106Z	E CAPACITOR	10MF 20% 50V	
	C 681	NCB31CK-103X	C CAPACITOR				C2598	QETN1HM-475Z	E CAPACITOR	4.7MF 20% 50V	
	C 682	NCB31CK-103X	C CAPACITOR				D 607	1SS355-X	DIODE		
	C 683	NCB31CK-103X	C CAPACITOR				D 608	1SS355-X	DIODE		
	C 684	QETN0JM-107Z	E CAPACITOR	100MF 20% 6.3V			IC601	AK4527BVQ	IC		
	C 685	QETN1CM-476Z	E CAPACITOR	47MF 20% 16V			IC609	BA15218F-XE	IC		
	C 686	QETN1CM-476Z	E CAPACITOR	47MF 20% 16V			IC610	BA15218F-XE	IC		
	C 687	NCB31CK-103X	C CAPACITOR				IC611	BU4066BCF-X	IC		
	C 688	QETN0JM-107Z	E CAPACITOR	100MF 20% 6.3V			IC621	TC7SU04FU-X	IC		
	C 689	NCB31CK-103X	C CAPACITOR				IC622	TC7SU04FU-X	IC		
	C 690	QETN0JM-107Z	E CAPACITOR	100MF 20% 6.3V			IC631	TC9446F-014	IC		
	C 693	NCB31CK-103X	C CAPACITOR				IC641	W24L010AJ-12-X	IC		
	C 694	NCB31CK-103X	C CAPACITOR				IC650	BA15218F-XE	IC		
	CN681	QGB2510K1-20	B TO B CONNE				IC651	BA15218F-XE	IC		
	C2500	QETN1CM-226Z	E CAPACITOR	22MF 20% 16V			IC652	IMX9-W	TRANSISTOR		
	C2503	QETN1HM-475Z	E CAPACITOR	4.7MF 20% 50V			IC661	BA15218F-XE	IC		
	C2504	QETN1HM-475Z	E CAPACITOR	4.7MF 20% 50V			IC662	IMX9-W	TRANSISTOR		
	C2507	NCS31HJ-330X	C CAPACITOR				IC671	UPD784215AGC103	IC		

■ Electrical parts list (DSP board)

Block No. 04

△	Item	Parts number	Parts name	Remarks	Area	△	Item	Parts number	Parts name	Remarks	Area
	IC672	TC7SET32FU-X	IC				R 674	NRSA63J-432X	MG RESISTOR		
	IC681	PQ3DZ53-X	IC				R 675	NRSA63J-432X	MG RESISTOR		
	IC682	IMX9-W	TRANSISTOR				R 676	NRSA63J-432X	MG RESISTOR		
	IC683	RN5RZ33BA-X	IC				R 677	NRSA63J-822X	MG RESISTOR		
	IC690	BA15218F-XE	IC				R 678	NRSA63J-822X	MG RESISTOR		
	IC691	BA15218F-XE	IC				R 679	NRSA63J-822X	MG RESISTOR		
	J 601	QNN0347-001	PIN JACK				R 680	NRSA63J-822X	MG RESISTOR		
	K 601	NQR0269-004X	FERRITE BEADS				R 681	NRSA63J-103X	MG RESISTOR		
	K 681	NQR0319-001X	F BEADS				R 682	NRSA63J-103X	MG RESISTOR		
	K 682	NQR0319-001X	F BEADS				R 683	NRSA63J-0R0X	MG RESISTOR		
	K 687	NQR0319-001X	F BEADS				R 684	NRSA63J-0R0X	MG RESISTOR		
	K 688	NQR0319-001X	F BEADS				R 685	NRSA63J-103X	MG RESISTOR		
	LC631	NQR0321-001X	EMI FILTER				R 686	NRSA63J-151X	MG RESISTOR		
	Q 601	DTC114YE-X	TRANSISTOR				R 688	NRSA63J-0R0X	MG RESISTOR		
	Q 607	DTA144EKA-X	TRANSISTOR				R 691	NRSA63J-221X	MG RESISTOR		
	Q 670	DTC114YE-X	TRANSISTOR				R 692	NRSA63J-221X	MG RESISTOR		
	Q 671	2SD2114K/VW/-X	TRANSISTOR				R 693	NRSA63J-221X	MG RESISTOR		
	Q 672	DTC114YE-X	TRANSISTOR				R 694	NRSA63J-221X	MG RESISTOR		
	Q 673	DTA144EKA-X	TRANSISTOR				R 695	NRSA63J-221X	MG RESISTOR		
	Q2501	DTA144EKA-X	TRANSISTOR				R 696	NRSA63J-221X	MG RESISTOR		
	R 600	NRSA63J-0R0X	MG RESISTOR				R2500	NRSA63J-102X	MG RESISTOR		
	R 601	NRSA63J-473X	MG RESISTOR				R2501	NRSA63J-104X	MG RESISTOR		
	R 602	NRSA63J-473X	MG RESISTOR				R2502	NRSA63J-104X	MG RESISTOR		
	R 603	NRSA63J-473X	MG RESISTOR				R2507	NRSA63J-223X	MG RESISTOR		
	R 606	NRSA63J-221X	MG RESISTOR				R2508	NRSA63J-223X	MG RESISTOR		
	R 607	NRSA63J-221X	MG RESISTOR				R2509	NRSA63J-223X	MG RESISTOR		
	R 608	NRSA63J-221X	MG RESISTOR				R2510	NRSA63J-223X	MG RESISTOR		
	R 609	NRSA63J-221X	MG RESISTOR				R2511	NRSA63J-103X	MG RESISTOR		
	R 611	NRSA63J-221X	MG RESISTOR				R2512	NRSA63J-103X	MG RESISTOR		
	R 612	NRSA63J-221X	MG RESISTOR				R2513	NRSA63J-103X	MG RESISTOR		
	R 613	NRSA63J-822X	MG RESISTOR				R2514	NRSA63J-103X	MG RESISTOR		
	R 615	NRSA63J-432X	MG RESISTOR				R2515	NRSA63J-103X	MG RESISTOR		
	R 617	NRSA63J-103X	MG RESISTOR				R2516	NRSA63J-103X	MG RESISTOR		
	R 618	NRSA63J-103X	MG RESISTOR				R2517	NRSA63J-103X	MG RESISTOR		
	R 621	NRSA63J-221X	MG RESISTOR				R2518	NRSA63J-103X	MG RESISTOR		
	R 622	NRSA63J-750X	MG RESISTOR				R2519	NRSA63J-331X	MG RESISTOR		
	R 623	NRSA63J-101X	MG RESISTOR				R2520	NRSA63J-331X	MG RESISTOR		
	R 625	NRSA63J-101X	MG RESISTOR				R2521	NRSA63J-331X	MG RESISTOR		
	R 627	NRSA63J-472X	MG RESISTOR				R2522	NRSA63J-331X	MG RESISTOR		
	R 628	NRSA63J-183X	MG RESISTOR				R2525	NRSA63J-102X	MG RESISTOR		
	R 629	NRSA63J-101X	MG RESISTOR				R2526	NRSA63J-102X	MG RESISTOR		
	R 632	NRSA63J-0R0X	MG RESISTOR				R2527	NRSA63J-104X	MG RESISTOR		
	R 633	NRSA63J-221X	MG RESISTOR				R2528	NRSA63J-104X	MG RESISTOR		
	R 639	NRSA63J-472X	MG RESISTOR				R2529	NRSA63J-103X	MG RESISTOR		
	R 640	NRSA63J-0R0X	MG RESISTOR				R2530	NRSA63J-103X	MG RESISTOR		
	R 641	NRSA63J-102X	MG RESISTOR				R2531	NRSA63J-752X	MG RESISTOR		
	R 642	NRSA63J-103X	MG RESISTOR				R2532	NRSA63J-752X	MG RESISTOR		
	R 643	NRSA63J-101X	MG RESISTOR				R2533	NRSA63J-103X	MG RESISTOR		
	R 644	NRSA63J-563X	MG RESISTOR				R2534	NRSA63J-103X	MG RESISTOR		
	R 645	NRSA63J-102X	MG RESISTOR				R2535	NRSA63J-103X	MG RESISTOR		
	R 646	NRSA63J-103X	MG RESISTOR				R2536	NRSA63J-103X	MG RESISTOR		
	R 647	NRSA63J-225X	MG RESISTOR				R2537	NRSA63J-104X	MG RESISTOR		
	R 648	NRSA63J-472X	MG RESISTOR				R2538	NRSA63J-104X	MG RESISTOR		
	R 657	NRSA63J-103X	MG RESISTOR				R2550	NRSA63J-272X	MG RESISTOR		
	R 661	NRSA63J-221X	MG RESISTOR				R2551	NRSA63J-103X	MG RESISTOR		
	R 662	NRSA63J-221X	MG RESISTOR				R2552	NRSA63J-103X	MG RESISTOR		
	R 663	NRSA63J-221X	MG RESISTOR				R2553	NRSA63J-153X	MG RESISTOR		
	R 664	NRSA63J-221X	MG RESISTOR				R2554	NRSA63J-153X	MG RESISTOR		
	R 669	NRSA63J-103X	MG RESISTOR				R2555	NRSA63J-822X	MG RESISTOR		
	R 670	NRSA63J-103X	MG RESISTOR				R2556	NRSA63J-822X	MG RESISTOR		
	R 671	NRSA63J-103X	MG RESISTOR				R2557	NRSA63J-103X	MG RESISTOR		
	R 672	NRSA63J-105X	MG RESISTOR				R2558	NRSA63J-223X	MG RESISTOR		
	R 673	NRSA63J-432X	MG RESISTOR				R2560	NRSA63J-105X	MG RESISTOR		

■ Electrical parts list (DSP board)

Block No. 04

△	Item	Parts number	Parts name	Remarks	Area
	R2561	NRSA63J-104X	MG RESISTOR		
	R2562	NRSA63J-104X	MG RESISTOR		
	R2563	NRSA63J-103X	MG RESISTOR		
	R2564	NRSA63J-103X	MG RESISTOR		
	R2565	NRSA63J-202X	MG RESISTOR		
	R2566	NRSA63J-202X	MG RESISTOR		
	R2567	NRSA63J-103X	MG RESISTOR		
	R2568	NRSA63J-103X	MG RESISTOR		
	R2575	NRSA63J-102X	MG RESISTOR		
	R2576	NRSA63J-102X	MG RESISTOR		
	R2577	NRSA63J-104X	MG RESISTOR		
	R2578	NRSA63J-104X	MG RESISTOR		
	R2581	NRSA63J-104X	MG RESISTOR		
	R2582	NRSA63J-104X	MG RESISTOR		
	R2583	NRSA63J-123X	MG RESISTOR		
	R2584	NRSA63J-223X	MG RESISTOR		
	R2585	NRSA63J-302X	MG RESISTOR		
	R2586	NRSA63J-332X	MG RESISTOR		
	R2587	NRSA63J-103X	MG RESISTOR		
	R2588	NRSA63J-103X	MG RESISTOR		
	R2589	NRSA63J-104X	MG RESISTOR		
	R2590	NRSA63J-333X	MG RESISTOR		
	R2592	NRSA63J-333X	MG RESISTOR		
	R2594	NRSA63J-333X	MG RESISTOR		
	R2595	NRSA63J-102X	MG RESISTOR		
	R2596	NRSA63J-102X	MG RESISTOR		
	R2597	NRSA63J-104X	MG RESISTOR		
	R2598	NRSA63J-104X	MG RESISTOR		
	UN661	GP1FA550RZ	OPT RECEIVER		
	UN662	GP1FA550RZ	OPT RECEIVER		
	UN663	GP1FA550TZ	OPT TRANSMITTER		
	UN664	GP1FA550RZ	OPT RECEIVER		
	X 631	NAX0385-001X	CRYSTAL		
	X 671	NAX0275-001X	1COSCIALLATOR		

■ Electrical parts list (Tuner board)

Block No. 05

△	Item	Parts number	Parts name	Remarks	Area
	AT101	QNB0014-001	ANT TERMINAL		
	BK 1	LV31618-001A	SHIELD BKT		
	C 101	NCB21HK-103X	C CAPACITOR		
	C 103	NCB21HK-223X	C CAPACITOR		
	C 105	NCB21HK-223X	C CAPACITOR		
	C 107	QEKC1CM-226Z	E CAPACITOR	22MF 20% 16V	
	C 111	NCB21HK-473X	C CAPACITOR		
	C 112	NDC21HJ-120X	C CAPACITOR		
	C 113	QCSB1HJ-120Y	C CAPACITOR	12PF 5% 50V	
	C 121	NDC21HJ-120X	C CAPACITOR		
	C 122	NDC21HJ-120X	C CAPACITOR		
	C 123	NCB21HK-473X	C CAPACITOR		
	C 126	NCS21HJ-101X	C CAPACITOR		
	C 128	QENC1HM-474Z	NP E CAPACITOR	.47MF 20% 50V	
	C 129	NCB21HK-102X	C CAPACITOR		
	C 130	QEKC1AM-107Z	E CAPACITOR	100MF 20% 10V	
	C 133	QEKC1CM-226Z	E CAPACITOR	22MF 20% 16V	
	C 134	NCB21HK-222X	C CAPACITOR		
	C 135	NCB21HK-223X	C CAPACITOR		
	C 136	QEKC1HM-105Z	E CAPACITOR	1.0MF 20% 50V	
	C 137	NCS21HJ-680X	C CAPACITOR		
	C 139	NCB21HK-393X	C CAPACITOR		
	C 140	NCB21HK-393X	C CAPACITOR		
	C 141	NCB21HK-473X	C CAPACITOR		
	C 143	NCB21HK-223X	C CAPACITOR		
	C 144	NCB21HK-473X	C CAPACITOR		
	C 146	QEKC1HM-105Z	E CAPACITOR	1.0MF 20% 50V	
	C 147	QEKC1HM-105Z	E CAPACITOR	1.0MF 20% 50V	
	C 148	QEKC1HM-224Z	E CAPACITOR	.22MF 20% 50V	
	C 149	QEKC1HM-105Z	E CAPACITOR	1.0MF 20% 50V	
	C 150	QEKC1CM-226Z	E CAPACITOR	22MF 20% 16V	
	C 156	QDGB1HK-102Y	C CAPACITOR		
	C 157	NCB21HK-473X	C CAPACITOR		
	C 158	QEKC1CM-226Z	E CAPACITOR	22MF 20% 16V	
	C 161	QEKC1CM-106Z	E CAPACITOR	10MF 20% 16V	
	C 162	QEKC1CM-106Z	E CAPACITOR	10MF 20% 16V	
	C 163	NCB21HK-223X	C CAPACITOR		
	C 164	NCB21HK-473X	C CAPACITOR		
	C 168	QEKC1HM-105Z	E CAPACITOR	1.0MF 20% 50V	
	C 184	QEKC1CM-107Z	E CAPACITOR	100MF 20% 16V	
	C 185	QEKC1CM-106Z	E CAPACITOR	10MF 20% 16V	
	C 186	QEKC1CM-106Z	E CAPACITOR	10MF 20% 16V	
	C 191	NCS21HJ-820X	C CAPACITOR		
	C 192	NCS21HJ-470X	C CAPACITOR		
	C 193	NCB21HK-561X	C CAPACITOR		
	C 194	NCB21HK-104X	C CAPACITOR		
	C 195	NCB21HK-331X	C CAPACITOR		
	C 196	QEKC1HM-225Z	E CAPACITOR	2.2MF 20% 50V	
	C 197	NCB21HK-473X	C CAPACITOR		
	C 199	QEKC1CM-106Z	E CAPACITOR	10MF 20% 16V	
	CF101	QAX0285-001Z	C FILTER		
	CF102	QAX0285-001Z	C FILTER		
	CF103	QAX0519-001Z	C FILTER		
	CN111	QGB2501K2-12	CONNECTOR		
	CN112	QGB2501K1-04	CONNECTOR		
	D 121	1SS133-T2	SI DIODE		
	D 123	1SS133-T2	SI DIODE		
	D 129	1SS133-T2	SI DIODE		
	D 131	1SS133-T2	SI DIODE		
	IC102	LA1838	IC		
	IC121	LC72136N	IC		
	IC191	SAA6588	IC(RDS)		
	L 112	QQL231K-2R7Y	INDUCTOR		

△	Item	Parts number	Parts name	Remarks	Area
	Q 102	2SC535/BC/-T	TRANSISTOR		
	Q 103	2SC461/BC/-T	TRANSISTOR		
	Q 111	KTC3199/GL/-T	TRANSISTOR		
	Q 112	KTC3199/GL/-T	TRANSISTOR		
	Q 113	DTA114YKA-X	TRANSISTOR		
	Q 121	KRA103M-T	TRANSISTOR		
	R 103	NRSA02J-221X	MG RESISTOR		
	R 104	NRSA02J-272X	MG RESISTOR		
	R 105	NRSA02J-391X	MG RESISTOR		
	R 106	NRSA02J-102X	MG RESISTOR		
	R 107	NRSA02J-561X	MG RESISTOR		
	R 108	NRSA02J-332X	MG RESISTOR		
	R 109	NRSA02J-221X	MG RESISTOR		
	R 111	NRSA02J-182X	MG RESISTOR		
	R 112	QRE141J-182Y	C RESISTOR	1.8K 5% 1/4W	
	R 114	NRSA02J-272X	MG RESISTOR		
	R 115	NRSA02J-104X	MG RESISTOR		
	R 119	NRSA02J-103X	MG RESISTOR		
	R 122	NRSA02J-472X	MG RESISTOR		
	R 124	NRSA02J-222X	MG RESISTOR		
	R 126	NRSA02J-562X	MG RESISTOR		
	R 127	NRSA02J-822X	MG RESISTOR		
	R 128	NRSA02J-472X	MG RESISTOR		
	R 129	NRSA02J-222X	MG RESISTOR		
△	R 130	QRZ9005-680X	F RESISTOR	68 1/0W	
	R 132	NRSA02J-393X	MG RESISTOR		
	R 133	NRSA02J-392X	MG RESISTOR		
	R 134	NRSA02J-102X	MG RESISTOR		
	R 140	NRSA02J-473X	MG RESISTOR		
	R 141	NRSA02J-102X	MG RESISTOR		
	R 142	NRSA02J-470X	MG RESISTOR		
	R 143	NRSA02J-562X	MG RESISTOR		
	R 144	NRSA02J-332X	MG RESISTOR		
	R 145	NRSA02J-103X	MG RESISTOR		
	R 146	NRSA02J-472X	MG RESISTOR		
	R 147	NRSA02J-332X	MG RESISTOR		
	R 150	NRSA02J-331X	MG RESISTOR		
	R 157	NRSA02J-332X	MG RESISTOR		
	R 158	NRSA02J-332X	MG RESISTOR		
	R 161	NRSA02J-102X	MG RESISTOR		
	R 162	NRSA02J-102X	MG RESISTOR		
	R 182	NRSA02J-103X	MG RESISTOR		
	R 183	NRSA02J-103X	MG RESISTOR		
	R 184	NRSA02J-103X	MG RESISTOR		
	R 191	NRSA02J-102X	MG RESISTOR		
	R 192	NRSA02J-474X	MG RESISTOR		
	R 193	NRSA02J-103X	MG RESISTOR		
	R 194	NRSA02J-103X	MG RESISTOR		
	RF101	QAU0119-001	FRONT END	FOR FTZ	
	T 111	QQR0871-001	COIL BLOCK		
	T 142	QQR0973-001	IFT		
	X 121	QAX0402-001	CRYSTAL		
	X 191	QAX0263-001Z	CRYSTAL		

Packing materials and accessories parts list

Block No.

M	2	M	M
---	---	---	---

Block No.

M	3	M	M
---	---	---	---

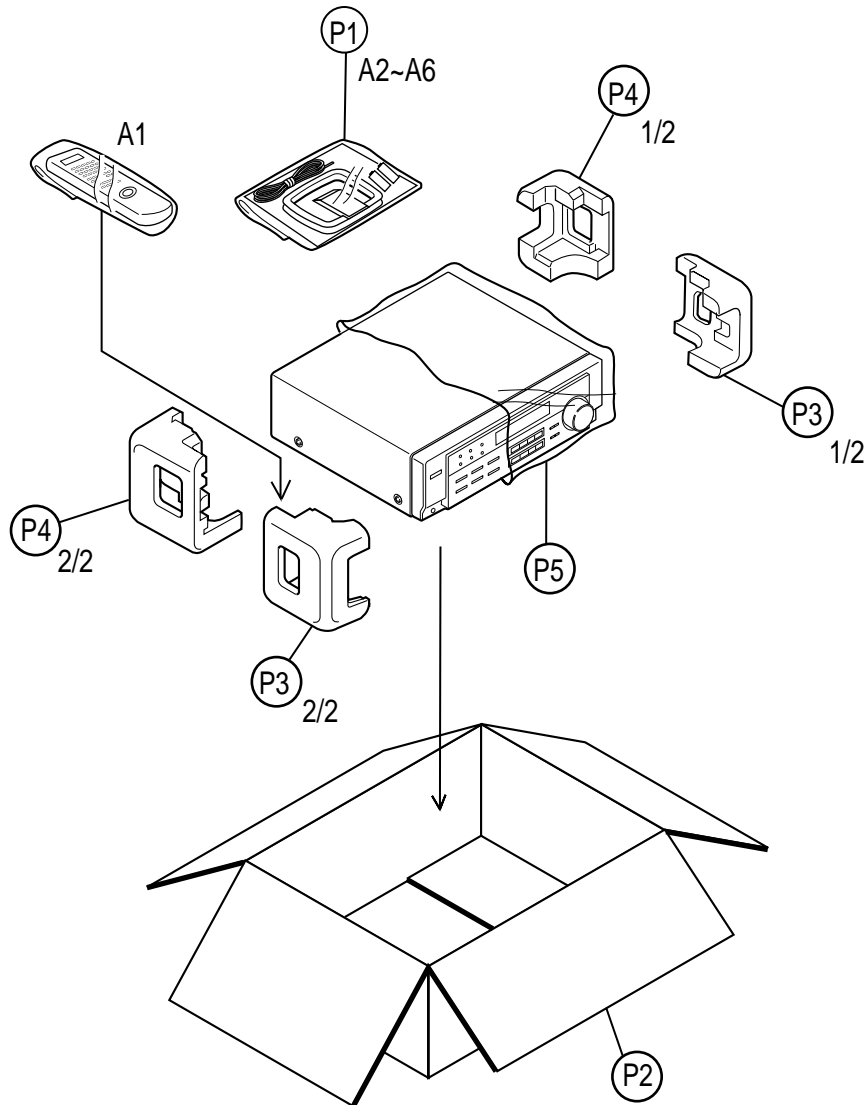

Parts list (Packing)

Block No. M2MM

△	Item	Parts number	Parts name	Q'ty	Description	Area
	P 1	QPA02503505P	POLY BAG	1	FOR INST	
	P 2	LV20983-011A	CARTON BOX	1	RX-7010RBK	
		LV20983-013A	CARTON BOX	1	RX-7012RSL	
	P 3	LV20925-001A	PACKING PAD	1		
	P 4	LV20926-001A	PACKING PAD	1		
	P 5	QPC06507015P	POLY BAG	1	FOR SET	

Parts list (Accessories)

Block No. M3MM

△	Item	Parts number	Parts name	Q'ty	Description	Area
	A 1	RM-SRX7010R	REMOCON	1	RX-7010RBK	
		RM-SRX7012R	W.LESS REMOCON	1	RX-7012RSL	
	A 2	-----	BATTERY	2		
	A 3	LVT0579-006A	INST BOOK	1	FRE, SPA, ITA	EN
		LVT0579-004A	INST BOOK	1	GER, FRE, DUT	E
		LVT0579-006A	INST BOOK	1	SWE, FIN, DAN, GER	EN
	A 4	EWP503-001C	ANT WIRE	1		
	A 5	QAL0204-001	AM LOOP ANT	1		
	A 6	BT-54008-2	W CARD	1		EN
		BT-54013-2	W CARD	1		E

JVC

VICTOR COMPANY OF JAPAN, LIMITED

AUDIO & COMMUNICATION BUSINESS DIVISION

PERSONAL & MOBILE NETWORK BUSINESS UNIT. 10-1,1chome,Ohwatari-machi,Maebashi-city,371-8543,Japan

JVC



AUDIO/VIDEO CONTROL RECEIVER

RX-7010RBK / RX-7012RSL

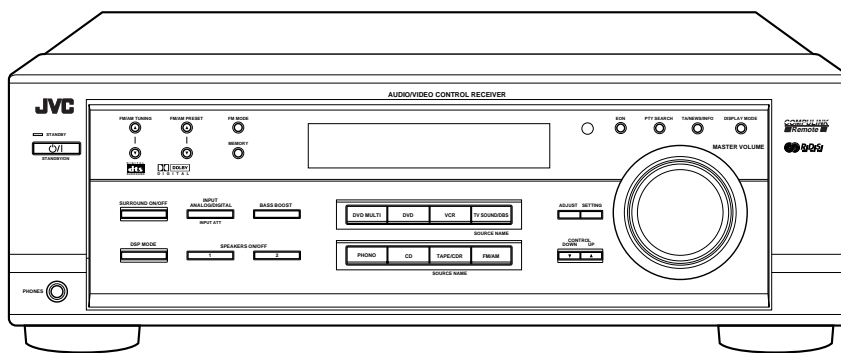
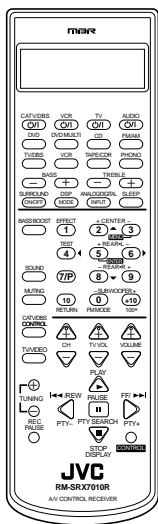

COMPU LINK
Remote

DIGITAL
dts
SURROUND

DOLBY
DIGITAL

DTS
ES



INSTRUCTIONS

For Customer Use:

Enter below the Model No. and Serial No. which are located either on the rear, bottom or side of the cabinet. Retain this information for future reference.

Model No. _____

Serial No. _____

LVT0579-005A

[B]

Warnings, Cautions and Others

IMPORTANT for the U.K.

DO NOT cut off the mains plug from this equipment. If the plug fitted is not suitable for the power points in your home or the cable is too short to reach a power point, then obtain an appropriate safety approved extension lead or consult your dealer.

BE SURE to replace the fuse only with an identical approved type, as originally fitted.

If nonetheless the mains plug is cut off ensure to remove the fuse and dispose of the plug immediately, to avoid a possible shock hazard by inadvertent connection to the mains supply.

If this product is not supplied fitted with a mains plug then follow the instructions given below:

IMPORTANT.

DO NOT make any connection to the terminal which is marked with the letter E or by the safety earth symbol or coloured green or green-and-yellow.

The wires in the mains lead on this product are coloured in accordance with the following code:

Blue : Neutral
Brown : Live

As these colours may not correspond with the coloured markings identifying the terminals in your plug proceed as follows:

The wire which is coloured blue must be connected to the terminal which is marked with the letter N or coloured black.

The wire which is coloured brown must be connected to the terminal which is marked with the letter L or coloured red.

IF IN DOUBT - CONSULT A COMPETENT ELECTRICIAN.

CAUTION

To reduce the risk of electrical shocks, fire, etc.:

1. Do not remove screws, covers or cabinet.
2. Do not expose this appliance to rain or moisture.

Caution — switch!

Disconnect the mains plug to shut the power off completely.

The  switch in any position does not disconnect the mains line. The power can be remote controlled.

CAUTION

- Do not block the ventilation openings or holes.
(If the ventilation openings or holes are blocked by a newspaper or cloth, etc., the heat may not be able to get out.)
- Do not place any naked flame sources, such as lighted candles, on the apparatus.
- When discarding batteries, environmental problems must be considered and local rules or laws governing the disposal of these batteries must be followed strictly.
- Do not use this apparatus in a bathroom or places with water. Also do not place any containers filled with water or liquids (such as cosmetics or medicines, flower vases, potted plants, cups, etc.) on top of this apparatus.

SAFETY INSTRUCTIONS

“SOME DOS AND DON'TS ON THE SAFE USE OF EQUIPMENT”

This equipment has been designed and manufactured to meet international safety standards but, like any electrical equipment, care must be taken if you are to obtain the best results and safety is to be assured.

Do read the operating instructions before you attempt to use the equipment.

Do ensure that all electrical connections (including the mains plug, extension leads and interconnections between pieces of equipment) are properly made and in accordance with the manufacturer's instructions. Switch off and withdraw the mains plug when making or changing connections.

Do consult your dealer if you are ever in doubt about the installation, operation or safety of your equipment.

Do be careful with glass panels or doors on equipment.

DON'T continue to operate the equipment if you are in any doubt about it working normally, or if it is damaged in any way—switch off, withdraw the mains plug and consult your dealer.

DON'T remove any fixed cover as this may expose dangerous voltages.

DON'T leave equipment switched on when it is unattended unless it is specifically stated that it is designed for unattended operation or has a standby mode.

Switch off using the switch on the equipment and make sure that your family know how to do this.

Special arrangements may need to be made for infirm or handicapped people.

DON'T use equipment such as personal stereos or radios so that you are distracted from the requirements of traffic safety. It is illegal to watch television whilst driving.

DON'T listen to headphones at high volume as such use can permanently damage your hearing.

DON'T obstruct the ventilation of the equipment, for example with curtains or soft furnishings.

Overheating will cause damage and shorten the life of the equipment.

DON'T use makeshift stands and NEVER fix legs with wood screws — to ensure complete safety always fit the manufacturer's approved stand or legs with the fixings provided according to the instructions.

DON'T allow electrical equipment to be exposed to rain or moisture.

ABOVE ALL

- NEVER let anyone, especially children, push anything into holes, slots or any other opening in the case -this could result in a fatal electrical shock.;
- NEVER guess or take chances with electrical equipment of any kind — it is better to be safe than sorry!

Caution: Proper Ventilation

To avoid risk of electric shock and fire and to protect from damage.

Locate the apparatus as follows:

- Front: No obstructions open spacing.
- Sides: No obstructions in 10 cm from the sides.
- Top: No obstructions in 10 cm from the top.
- Back: No obstructions in 15 cm from the back
- Bottom: No obstructions, place on the level surface.

In addition, maintain the best possible air circulation as illustrated.

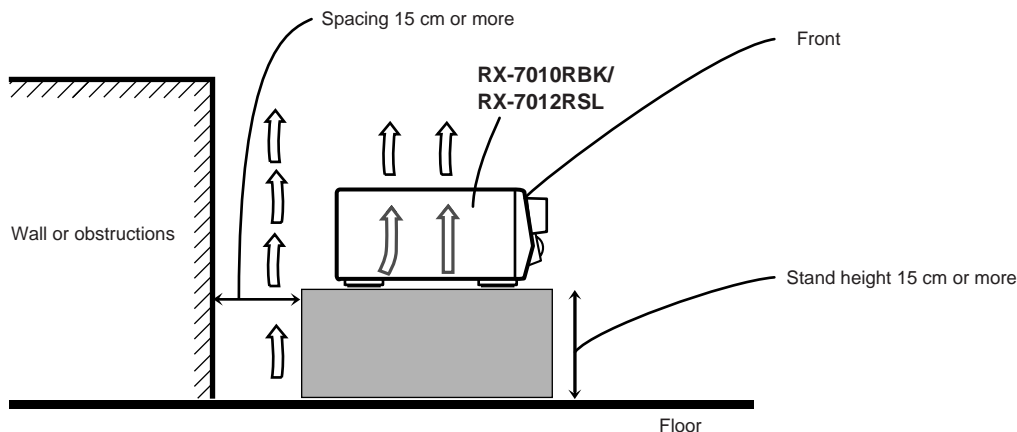
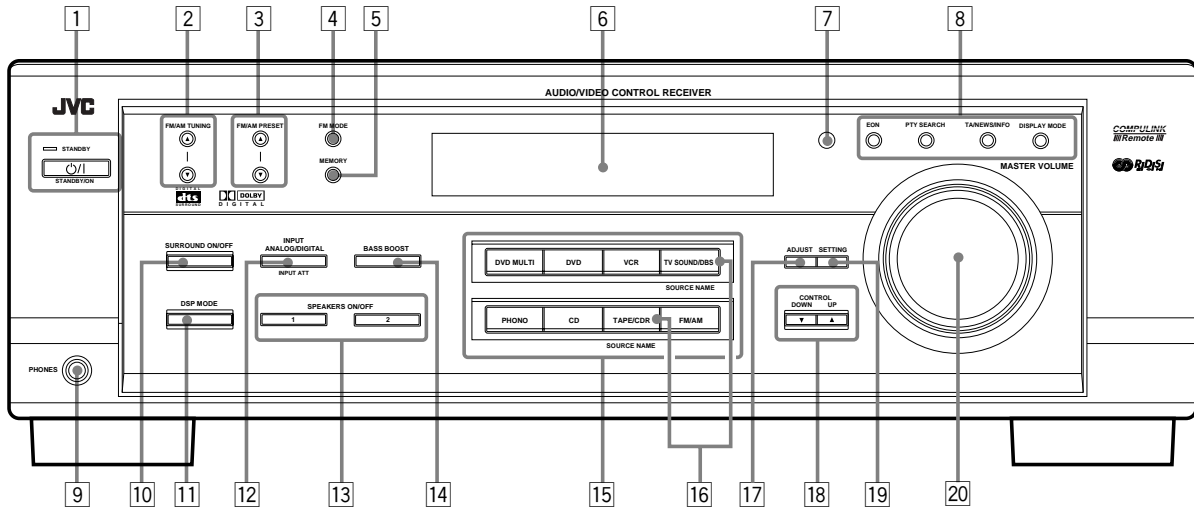

Table of Contents

Parts Identification	2	Using the DVD MULTI Playback Mode	30
Getting Started	3	Activating the DVD MULTI Playback Mode	30
Before Installation	3	COMPU LINK Remote Control System	31
Checking the Supplied Accessories	3	Operating JVC's Audio/Video Components ...	32
Connecting the FM and AM (MW/LW) Antennas	3	Operating Audio Components	32
Connecting the Speakers	4	Operating Video Components	34
Connecting Audio/Video Components	5	Operating Other Manufacturers' Video	
Connecting the Power Cord	9	Equipment	35
Putting Batteries in the Remote Control	9	Troubleshooting	39
Basic Operations	10	Specifications	40
Turning the Power On and Off (Standby)	10		
Selecting the Source to Play	10		
Adjusting the Volume	11		
Selecting the Front Speakers	11		
Muting the Sound	12		
Reinforcing the Bass	12		
Adjusting the Tone	12		
Attenuating the Input Signal	12		
Adjusting the Subwoofer Output Level	12		
Basic Settings	13		
Recording a Source	13		
Adjusting the Front Speaker Output Balance	13		
Changing the Source Name	13		
Setting the Subwoofer Information	14		
Setting the Speakers for the DSP Modes	14		
Digital Input (DIGITAL IN) Terminal Setting	16		
Selecting the Analog or Digital Input Mode	16		
Storing the Basic Settings and Adjustments	17		
Using the Sleep Timer	17		
Receiving Radio Broadcasts	18		
Tuning in Stations Manually	18		
Using Preset Tuning	18		
Selecting the FM Reception Mode	19		
Using the RDS (Radio Data System) to Receive FM Stations ..	20		
Searching for a Program by PTY Codes	20		
Switching to a Broadcast Program of Your Choice Temporarily	21		
Using the DSP Modes	23		
What are the DSP Modes?	23		
Reproducing the Sound Field	24		
Available DSP Modes According to the Speaker Arrangement ..	25		
Adjusting the Surround Modes	26		
Adjusting the DAP Modes	28		
Activating the DSP Modes	29		

Parts Identification

Become familiar with the buttons and controls on the receiver before use.
Refer to the pages in parentheses for details.



Remote Control

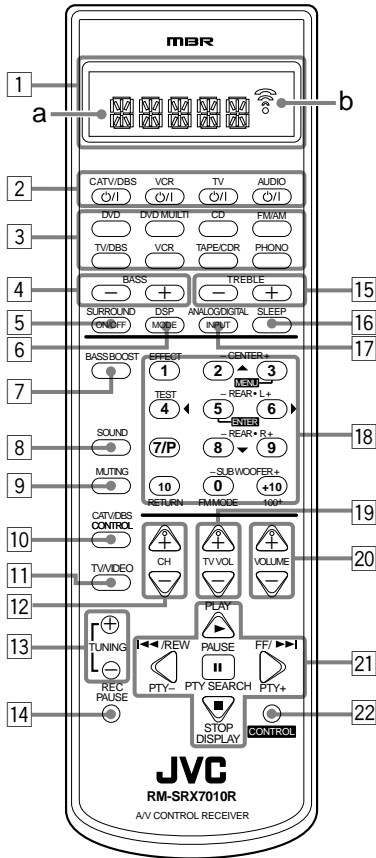

- 1 Display window (See below) *
a: Remote control operation mode indicator
b: Signal transmission indicator
- 2 O/I buttons (10, 34 – 38)
CATV/DBS, VCR, TV, AUDIO
- 3 Source selecting buttons (10, 17) *
DVD, DVD MULTI, CD, FM/AM, TV/DBS, VCR,
TAPE/CDR, PHONO
- 4 BASS +/- buttons (12)
- 5 SURROUND ON/OFF button (26, 29)
- 6 DSP MODE button (27 – 29)
- 7 BASS BOOST button (12)
- 8 SOUND button (12, 26 – 28, 30) *
- 9 MUTING button (12)
- 10 CATV/DBS CONTROL button (36) *
- 11 TV/VIDEO button (34, 35)
- 12 CH(annel) +/- buttons (34 – 37)
- 13 TUNING +/- buttons (18)
- 14 REC PAUSE button (33, 34, 37)
- 15 TREBLE +/- buttons (12)
- 16 SLEEP button (17)
- 17 ANALOG/DIGITAL INPUT button (17)
- 18 • 10 keys for selecting preset channels (19)
• 10 keys for adjusting sound (12, 19, 26 – 28, 30)
• 10 keys for operating audio/video components (32 – 38)
- 19 TV VOL(ume) +/- buttons (34, 35)
- 20 VOLUME +/- buttons (11)
- 21 • RDS operation buttons (20 – 21)
PTY SEARCH, PTY +/-, DISPLAY
- Operating buttons for audio/video components (32 – 34, 37, 38)
- 22 CONTROL button (33, 34) *

Front Panel

- 1 STANDBY/ON O/I button and STANDBY lamp (10)
- 2 FM/AM TUNING $\blacktriangle/\blacktriangledown$ buttons (18)
- 3 FM/AM PRESET $\blacktriangle/\blacktriangledown$ buttons (18)
- 4 FM MODE button (19)
- 5 MEMORY button (18)
- 6 Display (10)
- 7 Remote sensor (9)
- 8 RDS operation buttons (20 – 21)
EON, PTY SEARCH, TA/NEWS/INFO, DISPLAY MODE
- 9 PHONES jack (11)
- 10 SURROUND ON/OFF button (26, 29)
- 11 DSP MODE button (27 – 29)
- 12 INPUT ANALOG/DIGITAL button (17)
INPUT ATT button (12)
- 13 SPEAKERS ON/OFF 1 button (11)
SPEAKERS ON/OFF 2 button (11)
- 14 BASS BOOST button (12)
- 15 Source selecting buttons (10, 16)
DVD MULTI, DVD, VCR, TV SOUND/DBS,
PHONO, CD, TAPE/CDR, FM/AM
- 16 SOURCE NAME buttons (13)
• The TV SOUND/DBS button and TAPE/CDR
button also function as the SOURCE NAME
button.
- 17 ADJUST button (12, 13, 26 – 28, 30)
- 18 CONTROL UP \blacktriangle /DOWN \blacktriangledown buttons
- 19 SETTING button (14 – 16)
- 20 MASTER VOLUME control (11)



* When you press one of these buttons, the remote control operation mode appears on the display window for about 10 seconds.

Ex.: When you press CD button

Buttons on the Remote Control	Remote Control Operation Mode
FM/AM	TUNER
CD	CD
PHONO	PHONO
TAPE/CDR	TAPE
DVD	DVD
DVD MULTI	DVD

Buttons on the Remote Control	Remote Control Operation Mode
TV/DBS	TV
VCR	VCR
CATV/DBS CONTROL	DBS
CONTROL	Current setting or VCR or TAPE or CDDSC
SOUND	SOUND

Getting Started

This section explains how to connect audio/video components and speakers to the receiver, and how to connect the power supply.

Before Installation

General

- Be sure your hands are dry.
- Turn the power off to all components.
- Read the manuals supplied with the components you are going to connect.

Locations

- Install the receiver in a location that is level and protected from moisture.
- The temperature around the receiver must be between -5°C and 35°C (23°F and 95°F).
- Make sure there is good ventilation around the receiver. Poor ventilation could cause overheating and damage the receiver.

Handling the receiver

- Do not insert any metal object into the receiver.
- Do not disassemble the receiver or remove screws, covers, or cabinet.
- Do not expose the receiver to rain or moisture.

Checking the Supplied Accessories

Check to be sure you have all of the following items, which are supplied with the receiver.

The number in the parentheses indicates quantity of the pieces supplied.

- Remote Control (1)
- Batteries (2)
- AM (MW/LW) Loop Antenna (1)
- FM Antenna (1)

If anything is missing, contact your dealer immediately.

Connecting the FM and AM (MW/LW) Antennas

FM Antenna Connections

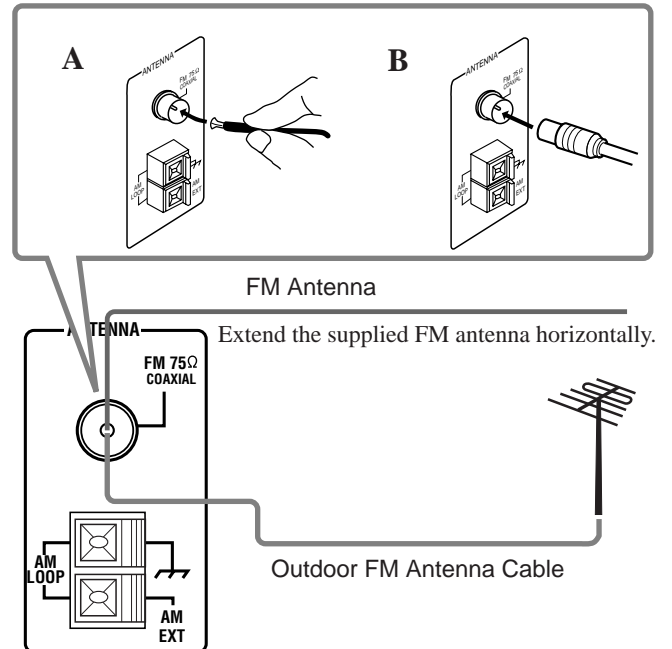

A. Using the Supplied FM Antenna

The FM antenna provided can be connected to the FM 75 Ω COAXIAL terminal as temporary measure.

B. Using the Standard Type Connector (Not Supplied)

A standard type connector (IEC or DIN45325) should be connected to the FM 75 Ω COAXIAL terminal.

Note:

If reception is poor, connect the outdoor antenna.

Before attaching a 75 Ω coaxial cable (the kind with a round wire going to an outdoor antenna), disconnect the supplied FM antenna.

AM (MW/LW) Antenna Connections

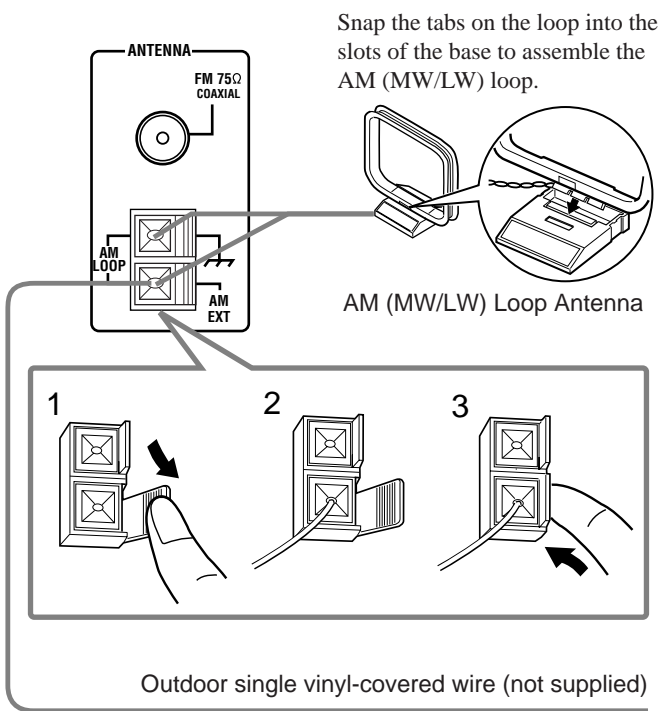

Turn the loop until you have the best reception.

Notes:

- If the AM (MW/LW) loop antenna wire is covered with vinyl, remove the vinyl by twisting it as shown in the diagram.
- Make sure the antenna conductors do not touch any other terminals, connecting cords and power cord. This could cause poor reception.
- If reception is poor, connect an outdoor single vinyl-covered wire to the AM EXT terminal. (Keep the AM (MW/LW) loop antenna connected.)

Connecting the Speakers

You can connect the following speakers:

- Two pairs of front speakers to produce normal stereo sound.
- One pair of rear speakers to enjoy the surround effect.
- One center speaker to produce more effective surround effect (to emphasize human voices).
- One subwoofer to enhance the bass.

IMPORTANT:

After connecting the speakers listed above, set the speaker setting information properly to obtain the best possible DSP effect. For details, see page 14.

For each speaker (except for a subwoofer), connect the (+) and (-) terminals on the rear panel to the (+) and (-) terminals marked on the speakers. For connecting a subwoofer, see page 5.

CAUTION:

Use speakers with the SPEAKER IMPEDANCE indicated by the speaker terminals.

Basic connecting procedure

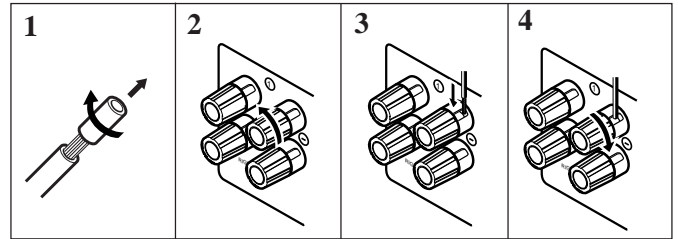

- 1 Cut, twist and remove the insulation at the end of each speaker signal cable (not supplied).
- 2 Turn the knob counterclockwise.
- 3 Insert the speaker signal cable.
- 4 Turn the knob clockwise.

Connecting the front speakers

You can connect two pairs of front speakers (one pair to the FRONT SPEAKERS ① terminals, and another pair to the FRONT SPEAKERS ② terminals).

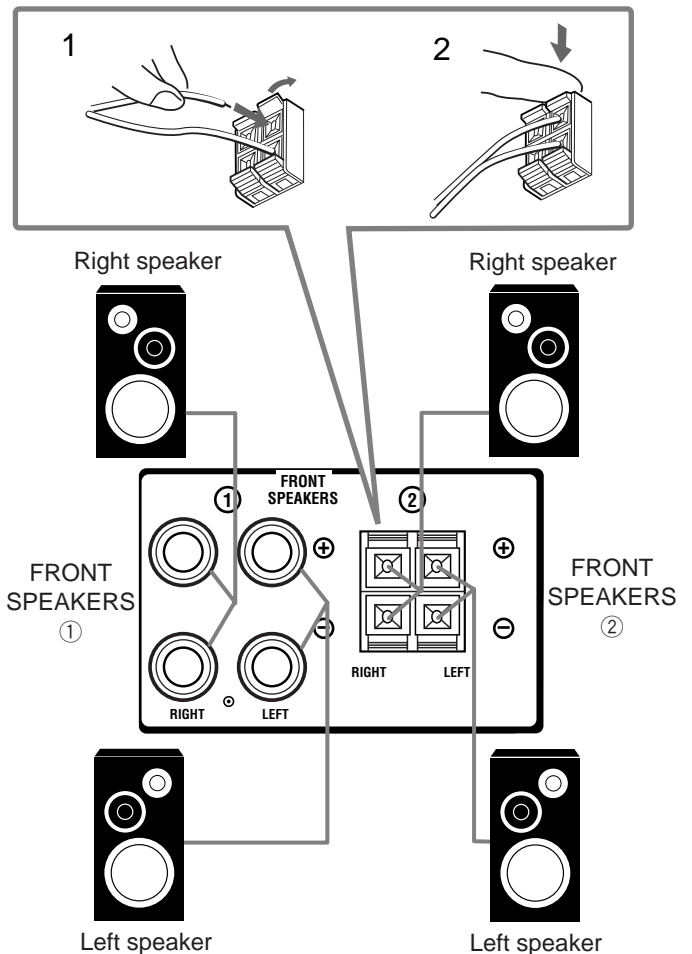

About the speaker impedance

The required speaker impedance of the front speakers does differ depending on whether both the FRONT SPEAKERS ① and FRONT SPEAKERS ② terminals are used or only one of them is used.

CASE 1 When you connect only one pair of front speakers

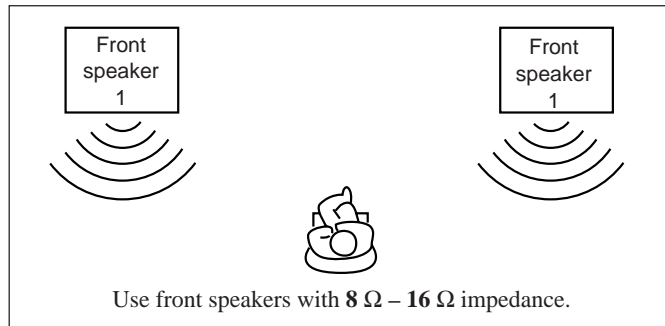

CASE 2 When you connect two pairs of front speakers

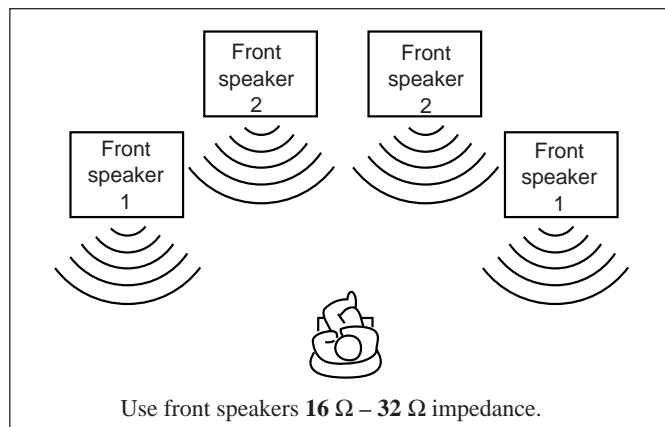

Connecting the rear and center speakers

Connect rear speakers to the REAR SPEAKERS terminals and a center speaker to the CENTER SPEAKER terminals.

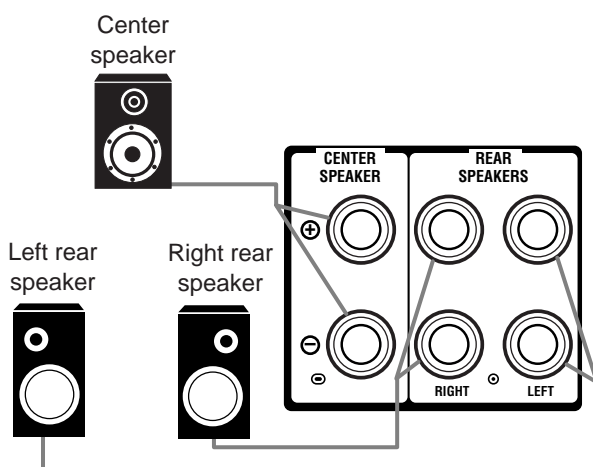

Connecting the subwoofer speaker

You can enhance the bass by connecting a subwoofer. Connect the input jack of a powered subwoofer to the SUBWOOFER OUT jack on the rear panel, using a cable with RCA pin plugs (not supplied).



Connecting Audio/Video Components

You can connect the following audio/video components to this receiver. Refer also to the manuals supplied with your components.

Audio Components	Video Components
• Turntable	• DVD player*
• CD player*	• TV*
• Cassette deck or CD recorder*	• DBS tuner*
	• VCR

* You can connect these components using the methods described in "Analog connections" (below) or in "Digital connections" (see page 8).

Analog connections

Audio component connections

Use the cables with RCA pin plugs (not supplied). Connect the white plug to the audio left jack, and the red plug to the audio right jack.

CAUTION:

If you connect a sound-enhancing device such as a graphic equalizer between the source components and this receiver, the sound output through this receiver may be distorted.

Turntable

If an earth cable is provided for your turntable, connect the cable to the AM (⏏) terminal on the rear panel.

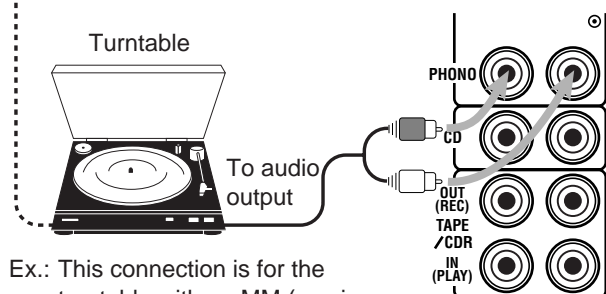

Ex.: This connection is for the turntable with an MM (moving-magnet) type cartridge.

Note:

Any turntables incorporating a small-output cartridge such as an MC (moving-coil) type must be connected to this receiver through a commercial head amplifier or step-up transformer. Direct connection may result in insufficient volume.

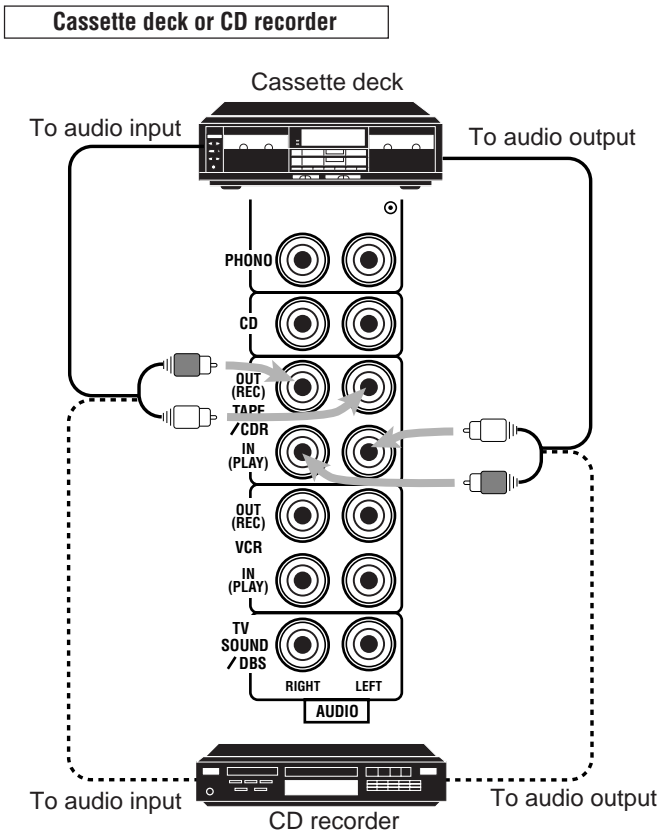
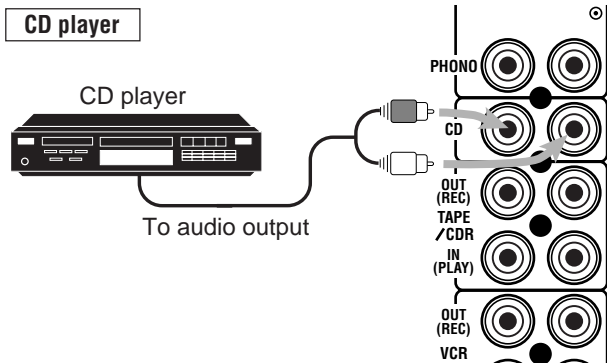

Note:

You can connect either a cassette deck or a CD recorder to the TAPE/CDR jacks. When connecting a CD recorder to the TAPE/CDR jacks, change the source name, which will be shown on the display when selected as the source, to "CDR." See page 13 for details.

If your audio components have a COMPU LINK jack

See also page 31 for detailed information about the connection and the COMPU LINK remote control system.

Video component connections

Use the cables with RCA pin plugs (not supplied).

Connect the white plug to the audio left jack, the red plug to the audio right jack, and the yellow plug to the video jack.

If your video components have S-video (Y/C-separation) terminals, connect them using S-video cables (not supplied). Connecting these video components through the S-video input/output terminals will give you better picture playback (or recording) quality.

IMPORTANT:

This receiver is equipped with both the composite video and S-video input/output terminals for connecting video components. You do not have to connect both the composite video and S-video terminals.

However, remember that the video signals from the composite video input terminals are output only through the composite video output terminals, while the ones from the S-video input terminals are output only through the S-video output terminals.

Therefore, if a recording video component and a playing video component are connected to the receiver through the different video terminals, you cannot record the picture from the playing component on the recording component. In addition, if the TV and a playing video component are connected to the receiver through the different video terminals, you cannot view the playback picture from the playing component on the TV.

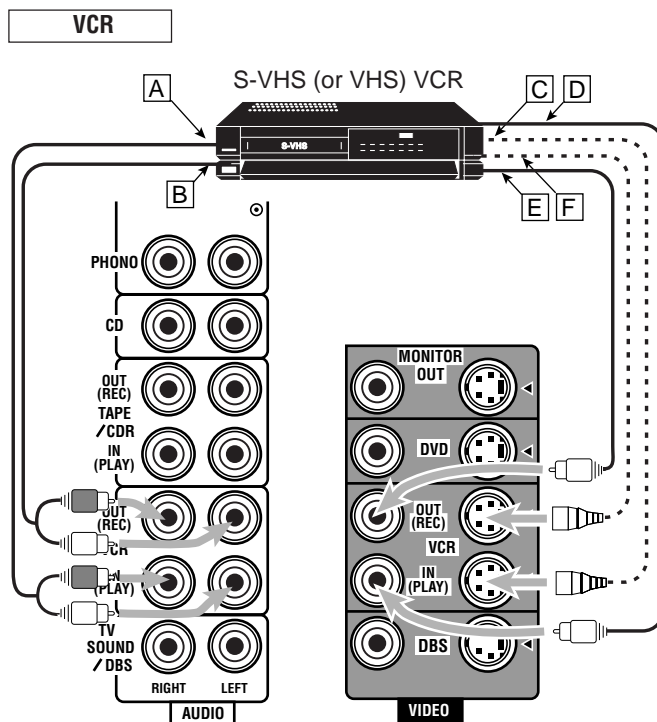

- A To left/right channel audio output
- B To left/right channel audio input
- C To S-video output
- D To composite video output
- E To composite video input
- F To S-video input

TV and/or DBS tuner

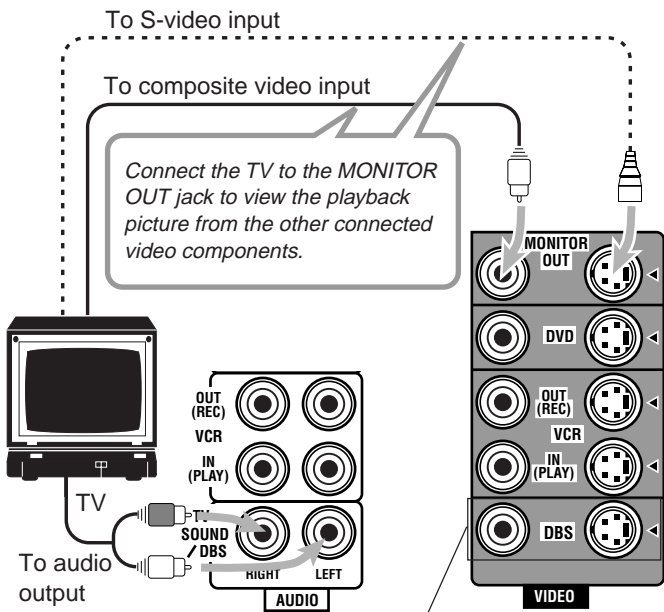

When connecting the TV to the AUDIO jacks (TV SOUND/DBS), DO NOT connect the TV's video output to these video input terminals.

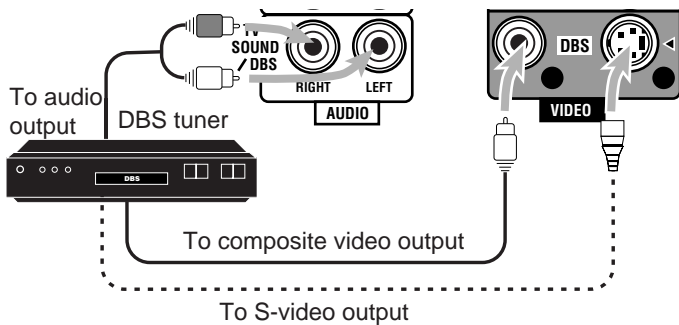

Note:

When connecting the DBS tuner to the TV SOUND/DBS jacks, change the source name, which will be shown on the display when selected as the source, to "DBS." See page 13 for details.

DVD player

- When you connect the DVD player with stereo output jacks:

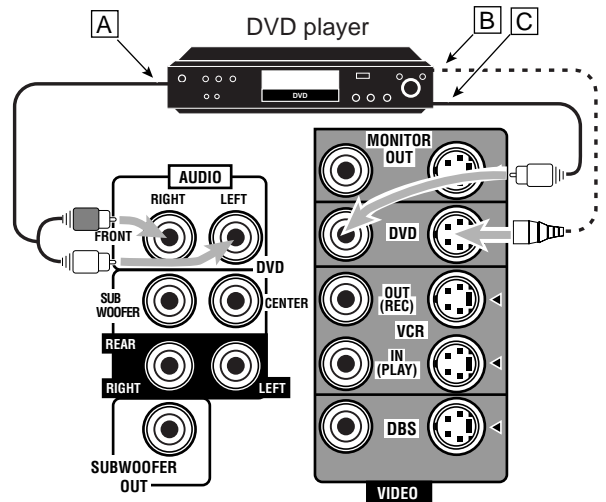

- A To front left/right channel audio output (or to audio mixed output if necessary)
- B To S-video output
- C To composite video output

- When you connect the DVD player with its analog discrete output (5.1 CH reproduction) jacks:

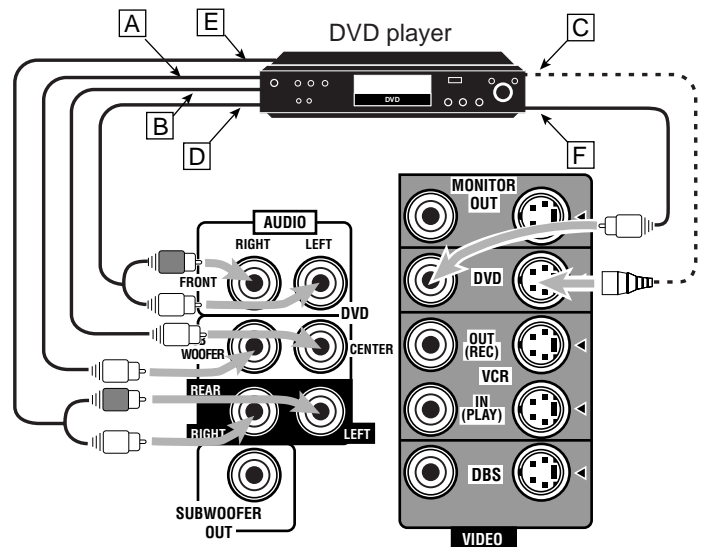

- A To center channel audio output
- B To subwoofer audio output
- C To S-video output
- D To front left/right channel audio output
- E To rear left/right channel audio output
- F To composite video output

Digital connections

This receiver is equipped with four DIGITAL IN terminals — one digital coaxial terminal and three digital optical terminals, and one DIGITAL OUT terminal.

You can connect any digital equipment such as —

- DBS tuner,
- Digital TV broadcast tuner,
- DVD player,
- CD player, and
- CD recorder.

IMPORTANT:

- When connecting the DVD player, digital TV broadcast tuner or DBS tuner using the digital terminals, you also need to connect it to the video jack (either composite video terminal or S-video terminal) on the rear. Without connecting it to the video jack, you can view no playback picture.
- After connecting the components using the DIGITAL IN terminals, set the following correctly if necessary.
 - Set the digital input (DIGITAL IN) terminal setting correctly. For details, see “Digital Input (DIGITAL IN) Terminal Setting” on page 16.
 - Select the digital input mode correctly. For details, see “Selecting the Analog or Digital Input Mode” on page 16.

Digital input terminals

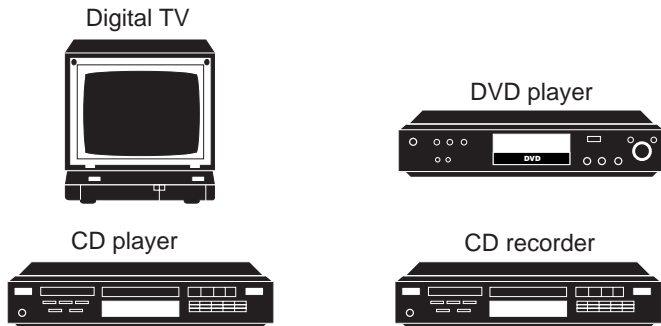

Digital coaxial cable (not supplied)
between digital coaxial terminals

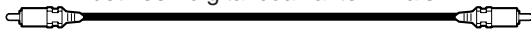

Digital optical cable (not supplied)
between digital optical terminals



When the component has a digital coaxial output terminal, connect it to the DIGITAL 1 (DVD) terminal, using the digital coaxial cable (not supplied).

When the component has a digital optical output terminal, connect it to the DIGITAL 2 (CD), DIGITAL 3 (TV), or DIGITAL 4 (CDR) terminal, using the digital optical cable (not supplied).

Before connecting a digital optical cable, unplug the protective plug.

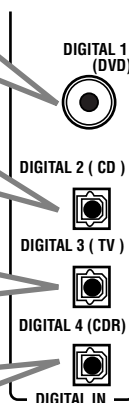
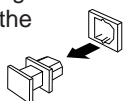

Notes:

- When shipped from the factory, the DIGITAL IN terminals have been set for use with the following components.
 - DIGITAL 1 (coaxial): For DVD player
 - DIGITAL 2 (optical): For CD player
 - DIGITAL 3 (optical): For digital TV broadcast tuner
 - DIGITAL 4 (optical): For CD recorder
- When you want to operate the CD player or CD recorder using the COMPU LINK remote control system, connect the target component also as described in “Analog connections” (see page 6).

Digital output terminal

CD recorder, etc.



Digital optical cable (not supplied)
between digital optical terminals



When the digital recording equipment such as a CD recorder has a digital optical input terminal, connecting it to the DIGITAL OUT terminal enables you to perform digital-to-digital recording.

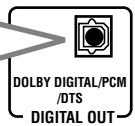

Connecting the Power Cord

Before plugging the receiver into an AC outlet, make sure that all connections have been made.

Plug the power cord into an AC outlet.

Keep the power cord away from the connecting cables and the antenna. The power cord may cause noise or screen interference. We recommend that you use a coaxial cable to connect the antenna, since it is well-shielded against interference.

Note:

The preset settings such as preset channels and sound adjustment may be erased in a few days in the following cases:

- When you unplug the power cord.
- When a power failure occurs.

CAUTIONS:

- Do not touch the power cord with wet hands.
- Do not pull on the power cord to unplug the cord. When unplugging the cord, always grasp the plug so as not to damage the cord.

Putting Batteries in the Remote Control

Before using the remote control, put two supplied batteries first. When using the remote control, aim the remote control directly at the remote sensor on the receiver.

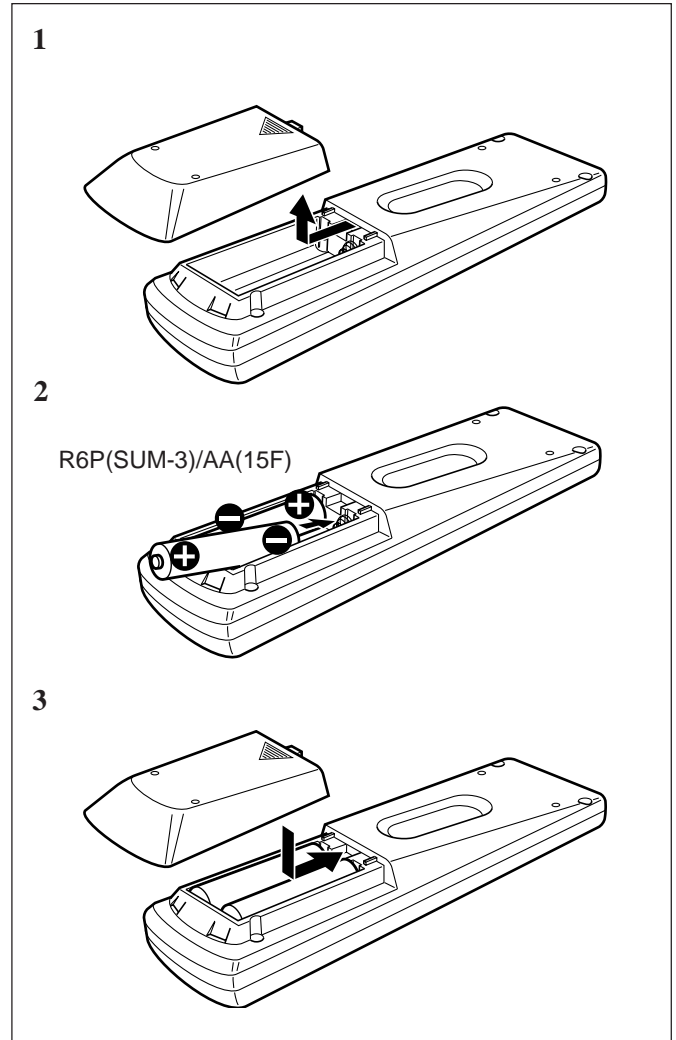

1. On the back of the remote control, remove the battery cover.
2. Insert batteries. Make sure to match the polarity: (+) to (+) and (-) to (-).
3. Replace the cover.

If the range or effectiveness of the remote control decreases, replace the batteries. Use two R6P(SUM-3)/AA(15F) type dry-cell batteries.

CAUTION:

Follow these precautions to avoid leaking or cracking cells:

- Place batteries in the remote control so they match the polarity: (+) to (+) and (-) to (-).
- Use the correct type of batteries. Batteries that look similar may differ in voltage.
- Always replace both batteries at the same time.
- Do not expose batteries to heat or flame.

Basic Operations

The following operations are commonly used when you play any sound source.

Turning the Power On and Off (Standby)

On the front panel:

To turn on the power, press STANDBY/ON . The STANDBY lamp goes off. The name of the current source (or station frequency) appears on the display.

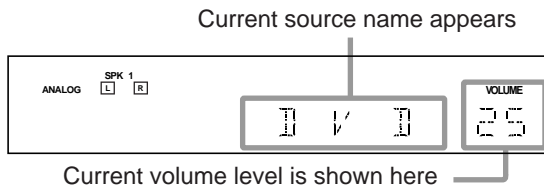
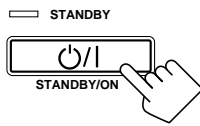

To turn off the power (into standby mode), press STANDBY/ON  again.

The STANDBY lamp lights up. A small amount of power is consumed in standby mode. To turn the power off completely, unplug the AC power cord.

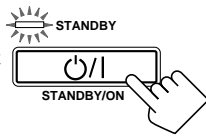

From the remote control:

To turn on the power, press AUDIO . The STANDBY lamp goes off. The name of the current source (or station frequency) appears on the display.



To turn off the power (into standby mode), press AUDIO  again. The STANDBY lamp lights up.

Selecting the Source to Play

Press one of the source selecting buttons.

On the front panel:

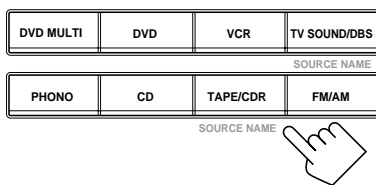

From the remote control:

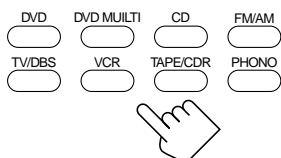

Selected source name appears

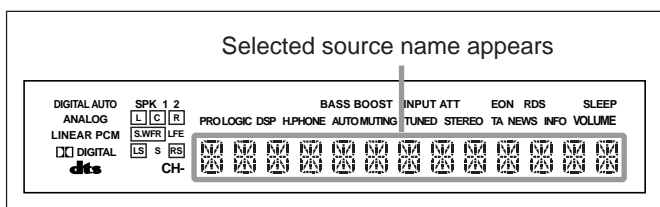

- DVD MULTI Select the DVD player for viewing the digital video disc using the analog discrete output mode (5.1 CH reproduction). To enjoy the DVD MULTI playback, see page 30.
- DVD Select the DVD player.
- VCR Select the video component connected to the VCR jacks.
- TV SOUND/DBS Select TV sounds (or the DBS tuner).
- PHONO* Select the turntable.
- CD* Select the CD player.
- TAPE/CDR* Select the cassette deck (or the CD recorder).
- FM/AM* Select an FM or AM (MW/LW) broadcast.
 - Each time you press the button, the band alternates between FM and AM (MW/LW).

Notes:

- When connecting a CD recorder (to the TAPE/CDR jacks), and a DBS tuner (to the TV SOUND/DBS jacks), change the source name shown on the display. For details, see page 13.
- When you press one of the source selecting buttons on the remote control marked above with an asterisk (*), the receiver automatically turns on.

Signal and speaker indicators on the display

The signal indicators light up in the following cases:

- Only the indicators for the incoming signals light up.
- When analog input is selected, "L" and "R" always light up.
- When "DVD MULTI" is selected as the source, "L," "C," "R," "LFE," "LS" and "RS" light up.

The speaker indicators light up only —:

- When the corresponding speaker is activated.

AND

- When the corresponding speaker is required for the DSP mode selected currently.

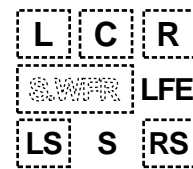
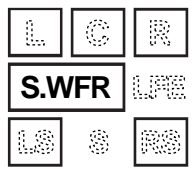
Signal indicators light up in red:	Speaker indicators light up in white:
	

- L:
 - When digital input is selected: Lights up when the left channel signal comes in.
 - When analog input is selected: Always lights up.
- R:
 - When digital input is selected: Lights up when the right channel signal comes in.
 - When analog input is selected: Always lights up.
- C: Lights up when the center channel signal comes in.
- LS: Lights up when the left rear channel signal comes in.
- RS: Lights up when the right rear channel signal comes in.
- S: Lights up when the monaural rear channel signal comes in.
- LFE: Lights up when the LFE channel signal comes in.

Notes:

- When "SUBWOOFER" is set to "YES,"  lights up.
- When you select "DVD MULTI," all the signal indicators except "S" light up.

Selecting different sources for picture and sound

You can watch picture from a video component while listening to sound from another component.

Press one of the audio source selecting buttons — PHONO, CD, TAPE/CDR, FM/AM, TV SOUND/DBS* (or TV/DBS on the remote control), while viewing the picture from a video component such as the VCR, DVD player, or DBS tuner, etc.

Notes:

- Once you have selected a video source, pictures of the selected source are sent to the TV until you select another video source.
- * The TV SOUND/DBS (or TV/DBS on the remote control) only works for selecting "DBS" as the source but not for selecting "TV SOUND (or TV on the remote control)." When you use the DBS tuner, change the source name correctly (see page 13).

Adjusting the Volume

On the front panel:

To increase the volume, turn MASTER VOLUME clockwise.

To decrease the volume, turn it counterclockwise.

- When you turn MASTER VOLUME rapidly, the volume level also changes rapidly.
- When you turn MASTER VOLUME slowly, the volume level also changes slowly.

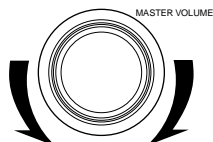

From the remote control:

To increase the volume, press VOLUME +.

To decrease the volume, press VOLUME -.

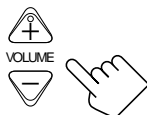

CAUTION:

Always set the volume to the minimum before starting any source. If the volume is set at its high level, the sudden blast of sound energy can permanently damage your hearing and/or ruin your speakers.

Note:

The volume level can be adjusted within the range of "0" (minimum) to "80" (maximum).

Selecting the Front Speakers

On the front panel ONLY:

When you have connected two pairs of the front speakers, you can select which to use.

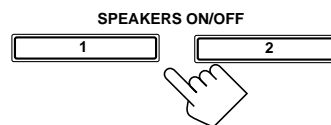

To use the speakers connected to the FRONT SPEAKERS ① terminals, press SPEAKERS ON/OFF 1 so that the SPK 1 indicator lights up on the display. (Make sure that the SPK 2 is not on the display.)

To use the speakers connected to the FRONT SPEAKERS ② terminals, press SPEAKERS ON/OFF 2 so that the SPK 2 indicator lights up on the display. (Make sure that the SPK 1 is not on the display.)

To use both sets of the speakers, press SPEAKERS ON/OFF 1 and 2 so that the SPK 1 and SPK 2 indicators light up on the display.

To use neither sets of the speakers, press SPEAKERS ON/OFF 1 and 2 so that the SPK 1 and SPK 2 indicators disappear from the display.

Notes:

- If you select any of the DSP modes while using both the speakers connected to the FRONT SPEAKERS ① and ② terminals, the speakers connected to the FRONT SPEAKERS ② terminals are deactivated.
- While the DSP MODE is in use, you can only select either the speakers connected to the FRONT SPEAKERS ① or ② terminals.

Listening only with headphones

You must turn off both pairs of speakers when you listen with headphones.

1. Connect a pair of headphones to the PHONES jack on the front panel.
2. Press SPEAKERS ON/OFF 1 and SPEAKERS ON/OFF 2 so that neither the SPK 1 nor SPK 2 indicator appears on the display.

This cancels the DSP mode currently selected, and activates the HEADPHONE mode (see below).

- "HEADPHONE" appears and H. PHONE indicator lights up on the display.

HEADPHONE mode:

This mode can reproduce the LFE channel signals, mixing them with the front channel signals. So you will not miss the subwoofer sounds even if you listen to a source using the headphones.

Notes:

- While in the HEADPHONE mode, you cannot use any DSP modes (see page 23.)
- Activating the speaker cancels the HEADPHONE mode and turns on the DSP mode previously selected.

CAUTION:

Be sure to turn down the volume before connecting or putting on headphones, as high volume can damage both the headphones and your hearing.

Muting the Sound

From the remote control ONLY:

Press **MUTING** to mute the sound through all speakers and headphones connected.



“MUTING” appears on the display and the volume turns off (the volume level indicator goes off).

To restore the sound, press **MUTING** again so that “OFF” appears on the display.

- Turning **MASTER VOLUME** on the front panel or pressing **VOLUME +/-** on the remote control also restores the sound.

Reinforcing the Bass

You can boost the bass level.

Press **BASS BOOST** on the front panel or on the remote control to select the bass boost function.

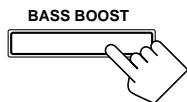

On the front panel



On the remote control

- Each time you press the button, the bass boost function turns on (“BASSBOOST ON”) and off (“BASSBOOST OFF”).
- Select “BASSBOOST ON” to activate the bass boost function. The **BASS BOOST** indicator lights up on the display.
- Select “BASSBOOST OFF” to cancel it. The indicator goes off.

Note:

This function affects the front speaker sounds only.

Adjusting the Tone

You can adjust the bass and treble sounds as you like.

Before you start, remember...

- There is a time limit in doing the following steps. If the setting is canceled before you finish, start from step 1 again.

On the front panel:

1. Press **ADJUST** repeatedly until “**BASS**” or “**TREBLE**” appears on the display.

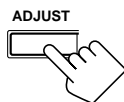

- Select “**BASS**” to adjust the bass sound level.
- Select “**TREBLE**” to adjust the treble sound level.

2. Press **CONTROL UP ▲/DOWN ▼** to adjust the bass or treble sound level (+10 dB to –10 dB).

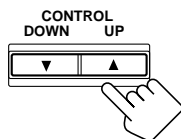

- Each time you press the button, the sound level changes by ± 2 steps.

From the remote control:

Press **BASS +/-** or **TREBLE +/-** to adjust the bass or treble sound level (+10 dB to –10 dB).

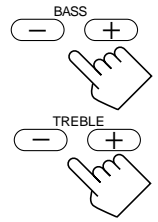

Attenuating the Input Signal

When the input level of the playing source is too high, the sounds will be distorted. If this happens, you need to attenuate the input signal level to prevent the sound distortion.

On the front panel ONLY:

Press and hold **INPUT ATT** so that the **INPUT ATT** indicator lights up on the display.

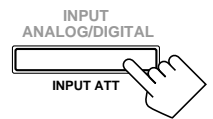

- Each time you press and hold the button, the Input Attenuator mode turns on (“**INPUT ATT ON**”) or off (“**INPUT NORMAL**”).

Notes:

- This function is available only for the sources connected using the analog terminals.
- This function takes effect when the DSP mode is in use.
- When selecting “**DVD MULTI**” as the source, this effect does not work.

Adjusting the Subwoofer Output Level

You can adjust the subwoofer output level if you have selected “**YES**” for the “**SUBWOOFER**” (see page 14).

Once it has been adjusted, the receiver memorizes the adjustment.

Before you start, remember...

- There is a time limit in doing the following steps. If the setting is canceled before you finish, start from step 1 again.
- When the front speakers are all deactivated, the subwoofer level cannot be adjusted.

On the front panel:

1. Press **ADJUST** repeatedly until “**SUBWFR LEVEL**” appears on the display.

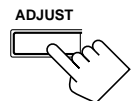

The display changes to show the current setting.

2. Press **CONTROL UP ▲/DOWN ▼** to adjust the subwoofer output level (+10 dB to –10 dB).

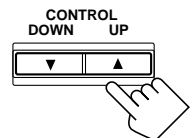

From the remote control:

1. Press **SOUND**.

The 10 keys are activated for sound adjustments.

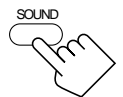

2. Press **SUBWOOFER +/-** to adjust the subwoofer output level (+10 dB to –10 dB).

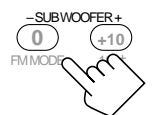

Basic Settings

Some of the following settings are required after connecting and positioning your speakers in your listening room, while others will make operations easier.

Recording a Source

For analog-to-analog recording

You can record any analog source through the receiver to —

- the cassette deck (or CD recorder) connected to the TAPE/CDR jacks, and
 - the VCR connected to the VCR jacks
- at the same time.

For digital-to-digital recording

You can record the currently selected digital input through the receiver to a digital recording device connected to the DIGITAL OUT terminal.

Notes:

- Analog-to-digital and digital-to-analog recordings are not possible.
- The output volume level, bass boost (see page 12), tone adjustment (see page 12), and DSP modes (see page 23) cannot affect the recording.
- The test tone signal (see pages 26 and 27) does not come out through the DIGITAL OUT terminal.

Adjusting the Front Speaker Output Balance

If the sounds you hear from the front right and left speakers are unequal, you can adjust the speaker output balance.

Before you start, remember....

- There is a time limit in doing the following steps. If the setting is canceled before you finish, start from step 1 again.

On the front panel ONLY:

1. Press **ADJUST** repeatedly until “L/R BALANCE” appears on the display.

The display changes to show the current setting.

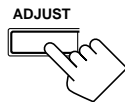

2. Press **CONTROL UP ▲/DOWN ▼** to adjust the balance.

- Pressing **CONTROL UP ▲** decreases the left channel output from CNTR (Center) to -21.
- Pressing **CONTROL DOWN ▼** decreases the right channel output from CNTR (Center) to -21.

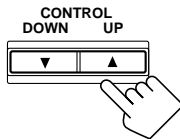

Changing the Source Name

When you have connected a CD recorder to the TAPE/CDR jacks or the DBS tuner to the TV SOUND/DBS jacks on the rear panel, change the source name which will be shown on the display when you select the CD recorder or DBS tuner as the source.

On the front panel ONLY:

When changing the source name from “TAPE” to “CDR”:

- Press and hold **TAPE/CDR/SOURCE NAME** to assign “CDR.”

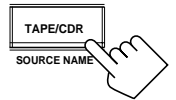

When changing the source name from “TV SOUND” to “DBS”:

- Press and hold **TV SOUND/DBS/SOURCE NAME** to assign “DBS.”



To change the source name to “TAPE” or “TV SOUND,” repeat the same procedure above — press and hold TAPE/CDR/SOURCE NAME to select “TAPE” or TV SOUND/DBS/SOURCE NAME to select “TV SOUND.”

Note:

Without changing the source name, you can still use the connected components. However, there may be some inconvenience.

- “TAPE” or “TV SOUND” will appear on the display when you select the CD recorder or DBS tuner.
- You cannot use the digital input (see page 16) for the CD recorder.
- You cannot use the COMPU LINK remote control system (see page 31) to operate the CD recorder.

Setting the Subwoofer Information

Register whether you have connected a subwoofer or not.

Before you start, remember....

- There is a time limit in doing the following steps. If the setting is canceled before you finish, start from step 1 again.

On the front panel ONLY:

1. Press **SETTING** repeatedly until **"SUBWOOFER"** appears on the display.

The display changes to show the current setting.

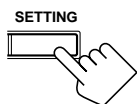

2. Press **CONTROL UP ▲/DOWN ▼** to register whether you have connected a subwoofer or not.

- Each time you press the button, the subwoofer setting alternates between "YES" and "NO."

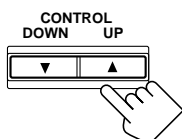

YES: Select this when a subwoofer is used. [SWFR] lights up on the display (see page 10).

NO: Select this when no subwoofer is used.

Setting the Speakers for the DSP Modes

To obtain the best possible surround sound of the DSP modes, you have to register the information about the speakers arrangement after all connections are completed.

Before you start, remember....

- There is a time limit in doing the following steps. If the setting is canceled before you finish, start from step 1 again.

Front, Center, and Rear Speaker Setting

Register the sizes of all the connected speakers.

- When you change your speakers, you need to register the information about the speakers again.

On the front panel ONLY:

1. Press **SETTING** repeatedly until **"FRONT SPK"** (Front Speaker), **"CENTER SPK"** (Center Speaker) or **"REAR SPK"** (Rear Speaker) appears on the display.

The display changes to show the current setting.

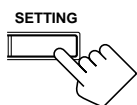

2. Press **CONTROL UP ▲/DOWN ▼** to select the appropriate item about the speaker selected in the above step.

- Each time you press the button, the display changes to show the following:

→ LARGE ↔ SMALL ↔ NO ←

LARGE: Select this when the speaker size is relatively large.

SMALL: Select this when the speaker size is relatively small.

NO: Select this when you have not connected a speaker. (Not selectable for the front speakers)

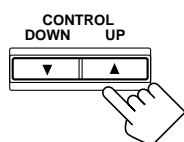

3. Repeat steps 1 and 2 to select the appropriate items for the other speakers.

Notes:

- Keep the following comment in mind as reference when adjusting.
 - If the size of the cone speaker unit built in your speaker is greater than 4 3/4 inches (12 cm), select "LARGE," and if it is smaller than 4 3/4 inches (12 cm), select "SMALL."
- If you have selected "NO" for the subwoofer setting, you can only select "LARGE" for the front speaker setting.
- If you have selected "SMALL" for the front speaker setting, you cannot select "LARGE" for the center and rear speaker settings.

Center Delay Time Setting

Register the delay time of the sound from the center speaker, comparing to that of the sound from the front speakers.

If the distance from your listening point to the center speaker is equal to that to the front speakers, select 0 msec. As the distance to the center speaker becomes shorter, the delay time increases.

- 1 msec increase (or decrease) in delay time corresponds to 1 13/16 inches (30 cm) decrease (or increase) in distance.
- When shipped from the factory, delay time is set to 0 msec.

On the front panel ONLY:

1. Press **SETTING** repeatedly until **"CENTER DELAY"** appears on the display.

The display changes to show the current setting.

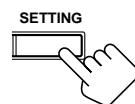

2. Press **CONTROL UP ▲/DOWN ▼** to select the delay time of the center speaker output.

- Press **CONTROL UP ▲** to increase the delay time from 0 msec ("C_DELAY 0MS") to 5 msec ("C_DELAY 5MS").
- Press **CONTROL DOWN ▼** to decrease the delay time from 5 msec ("C_DELAY 5MS") to 0 msec ("C_DELAY 0MS").

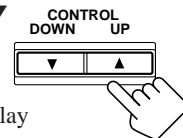

Notes:

- Center delay time is not valid for the DVD MULTI playback mode.
- You cannot adjust the center delay time when you have set "CENTER SPK" to "NO."

Rear Delay Time Setting

Register the delay time of the sound from the rear speakers, comparing to that of the sound from the front speakers.

If the distance from your listening point to the rear speakers is equal to that to the front speakers, select 0 msec. As the distance to the rear speakers becomes shorter, the delay time increases.

- 1 msec increase (or decrease) in delay time corresponds to 1 13/16 inches (30 cm) decrease (or increase) in distance.
- Rear delay time for Dolby Digital and DTS Digital Surround is to be set to 5 msec.
- When shipped from the factory, delay time is set to 5 msec.

On the front panel ONLY:

1. Press **SETTING** repeatedly until **"REAR DELAY"** appears on the display.

The display changes to show the current setting.

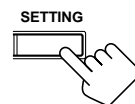

Continued to the next page.

2. Press CONTROL UP ▲/DOWN ▼ to select the delay time of the rear speaker output.

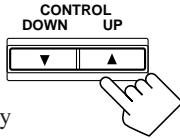

- Press CONTROL UP ▲ to increase the delay time from 0 msec (“R_DELAY 0MS”) to 15 msec (“R_DELAY 15MS”).
- Press CONTROL DOWN ▼ to decrease the delay time from 15 msec (“R_DELAY 15MS”) to 0 msec (“R_DELAY 0MS”).

Notes:

- Rear delay time is not valid for the DVD MULTI playback mode.
- You cannot adjust the rear delay time when you have set “REAR SPK” to “NO.”

Crossover Frequency Setting

Small speakers cannot reproduce the bass sound very well. So, if you have used a small speaker for any of the front, center, and rear channels, this receiver automatically reallocate the bass elements, originally assigned to the channel for which you have connected the small speaker, to another channel (for which you have connected the large speaker).

To use this function properly, you need to set the crossover frequency level according to the size of the small speaker connected.

- If you have selected “LARGE” for all speakers (see page 14), this function is set to “OFF” and cannot be adjusted.

On the front panel ONLY:

1. Press SETTING repeatedly until “CROSSOVER FRQ” (Crossover Frequency) appears on the display.

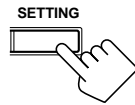

The display changes to show the current setting.

2. Press CONTROL UP ▲/DOWN ▼ to select the crossover frequency level according to the size of the small speaker connected.

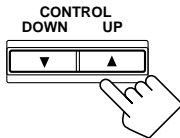

- Each time you press the button, the display changes to show the following:

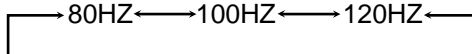

- Use the following comments as reference when adjusting.

80HZ: Select this when the cone speaker unit built in the speaker is about 4 3/4 inches (12 cm).

100HZ: Select this when the cone speaker unit built in the speaker is about 3 15/16 inches (10 cm).

120HZ: Select this when the cone speaker unit built in the speaker is about 3 3/16 inches (8 cm).

Note:

Crossover frequency is not valid for the DVD MULTI playback mode and HEADPHONE mode.

Low Frequency Effect Attenuator Setting

If the bass sound is distorted while playing back a source using Dolby Digital or DTS Digital Surround, follow the procedure below.

On the front panel ONLY:

1. Press SETTING repeatedly until “LFE ATT” (Low Frequency Effect Attenuator) appears on the display.

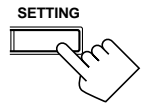

The display changes to show the current setting.

2. Press CONTROL UP ▲/DOWN ▼ to select the low frequency effect attenuator level.

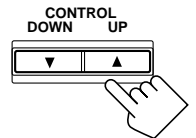

- Each time you press the button, the display changes to show the following:

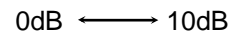

0dB: Normally select this.

10dB: Select this when the bass sound is distorted.

Notes:

- Low frequency effect attenuator is not valid for the DVD MULTI playback mode.
- This function takes effect only when the subwoofer (LFE) signals come in, (with “SUBWOOFER” set to “YES.”)

Dynamic Range Compression Setting

You can compress the dynamic range (difference between maximum sound and minimum sound) of the reproduced sound. This is useful when enjoying surround sound at night.

- This function takes effect only when playing back a source using Dolby Digital.

On the front panel ONLY:

1. Press SETTING repeatedly until “D_RANGE COMP” (Dynamic Range Compression) appears on the display.

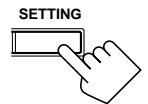

The display changes to show the current setting.

2. Press CONTROL UP ▲/DOWN ▼ to select the appropriate item about the compression level.

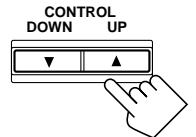

- Each time you press the button, the display changes to show the following:

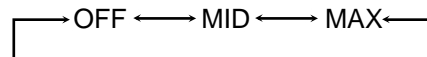

OFF: Select this when you want to enjoy surround with its full dynamic range. (No effect applied.)

MID: Select this when you want to reduce the dynamic range a little. (Factory setting.)

MAX: Select this when you want to apply the compression effect fully. (Useful at night.)

Note:

Dynamic Range Compression is not valid for the DTS Digital Surround and DVD MULTI playback mode.

Digital Input (DIGITAL IN) Terminal Setting

When you use the digital input terminals, you have to register what components are connected to which terminals (DIGITAL IN 1/2/3/4).

Before you start, remember....

- There is a time limit in doing the following steps. If the setting is canceled before you finish, start from step 1 again.

On the front panel ONLY:

To set the DIGITAL 1 terminal

1. Press **SETTING** repeatedly until "COAX DIG IN" appears on the display.

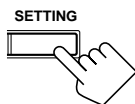

The display changes to show the current setting.

2. Press **CONTROL UP ▲/DOWN ▼** to select the appropriate digital terminal setting.

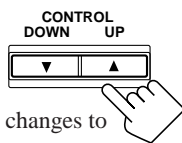

- Each time you press the button, the display changes to show the following:

1 DVD ⇄ 1 CDR ⇄ 1 TV (or 1 DBS*) ⇄ 1 CD ⇄
(back to the beginning)

* If you have changed the source name from "TV SOUND" to "DBS," "DBS" appears (see page 13.)

When the **DIGITAL 1** terminal is set, the **DIGITAL 2/3/4** terminal is automatically set as follows:

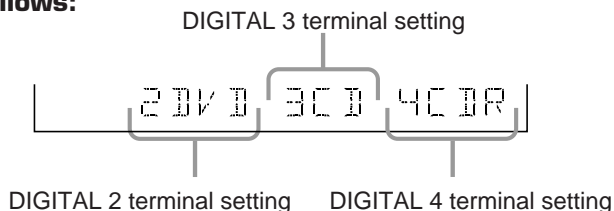

When the **DIGITAL 1** is set to "DVD"

2 CD 3 TV (or DBS*) 4 CDR

When the **DIGITAL 1** is set to "CDR"

2 DVD 3 CD 4 TV (or DBS*)

When the **DIGITAL 1** is set to "TV" or "DBS"

2 DVD 3 CD 4 CDR

When the **DIGITAL 1** is set to "CD"

2 DVD 3 TV (or DBS*) 4 CDR

* If you have changed the source name from "TV SOUND" to "DBS," "DBS" appears (see page 13.)

Notes:

- When shipped from the factory, the **DIGITAL IN** terminals can be used as the digital input for the following components.
 - **DIGITAL 1** (coaxial): For DVD player
 - **DIGITAL 2** (optical): For CD player
 - **DIGITAL 3** (optical): For digital TV broadcast tuner
 - **DIGITAL 4** (optical): For CDR
- When using the **DIGITAL 4** terminal for the CD recorder, you need to select "CDR" as the source name. (See page 13.)

Selecting the Analog or Digital Input Mode

When you have connected digital source components, you need to select the input mode correctly according to the connection you made.

Before you start, remember...

- The digital input (**DIGITAL IN**) terminal setting should be correctly done for the sources you want to select the digital input mode for. Without setting this digital input terminal correctly, you cannot change the input mode from analog input to digital input even if you follow the procedure below.

On the front panel:

1. Press one of the source selecting buttons (**DVD, TV SOUND/DBS, CD, or TAPE/CDR**)* for which you want to change the input mode.

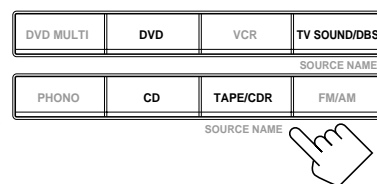

Note:

* Among the sources listed above, you can select the digital input only for the sources which you have selected the digital input terminals for. (See "Digital Input (DIGITAL IN) Terminal Setting.")

2. Press **INPUT ANALOG/DIGITAL** to change the input mode.

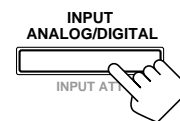

- Each time you press the button, the input mode changes as follows:

AUTO ↔ ANALOG
(Digital)

- AUTO:** Select this for the digital input mode. The receiver automatically detects the incoming signal format. (The **DIGITAL AUTO** indicator lights up on the display, and the digital signal indicator for the detected signals also light up.)*
- ANALOG:** Select this for the analog input mode.

* The followings are the analog/digital signal indicators on the display to indicate what type of the signal comes into the receiver.

- DIGITAL AUTO :** Lights up when "AUTO" is selected as the digital input mode.
- ANALOG :** Lights up when the analog input is selected.
- LINEAR PCM :** Lights up when Linear PCM signals come in.
- DIGITAL:** Lights up when Dolby Digital signals come in.
- dts :** Lights up when DTS Digital Surround signals come in.

Continued to the next page.

When playing a software encoded with the DTS Digital Surround, "AUTO" may not work properly and the following symptoms may occur:

- Sound does not come out at the beginning of playback.
- Noise comes out while using the searching or skipping function.

In this case, press CONTROL UP ▲/DOWN ▼ to select "DTS" while "AUTO" is lit on the display.

- Each time you press the button, the input mode changes as follows:

AUTO (Digital) ←→ DTS (Digital)

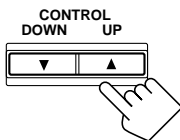

Note:

When you turn off the power or select another source, "DTS" setting is canceled and the digital input mode is automatically reset to "AUTO."

To change the input mode back to analog input, select "ANALOG" by pressing INPUT ANALOG/DIGITAL again.

From the remote control:

1. Press the source selecting button (DVD, CD, TV/DBS, or TAPE/CDR)* for which you want to change the input mode.

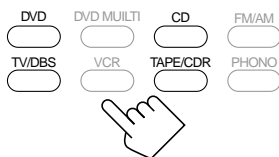

Note:

* Among the sources listed above, you can select the digital input only for the sources which you have selected the digital input terminals for. (See "Digital Input (DIGITAL IN) Terminal Setting.")

2. Press ANALOG/DIGITAL to change the input mode.

- Each time you press the button, the input mode changes as follows:

ANALOG ←→ AUTO (Digital)



When playing a software encoded with the DTS Digital Surround, "AUTO" may not work properly. In this case, press CONTROL UP ▲/DOWN ▼ on the front panel to select "DTS." (See above.)

Note:

You can only select "ANALOG" and "AUTO" using the remote control.

Storing the Basic Settings and Adjustments

You can assign and store different sound settings for each different playing source. By using this function, you do not have to change the settings every time you change the source. The stored settings for the newly selected source are automatically recalled.

The following can be stored for each source:

- Bass boost (see page 12)
- Tone adjustment (see page 12)
- Input attenuator mode (see page 12)
- Subwoofer output level (see page 12)
- Balance (see page 13)
- DSP modes
 - Surround mode (see page 26)
 - DAP mode (see page 28)
- DVD MULTI playback mode (see page 30)

The above settings are stored automatically in the following cases:

- When you turn on the power.
- When you change the source.
- When you assign the source name.

Notes:

- You cannot assign and store different settings for digital input mode and analog input mode.
- The DSP modes and DVD MULTI playback mode cannot be used at the same time.
- If the source is FM or AM (MW/LW), you can assign a different setting for each band.

Using the Sleep Timer

Using the Sleep Timer, you can fall asleep to music and know the receiver will turn off by itself rather than play all night.

From the remote control ONLY:

Press SLEEP repeatedly.

The SLEEP indicator lights up on the display, and the shut-off time changes as follows (in minutes):

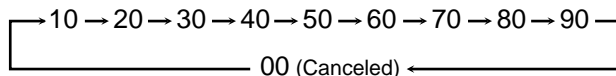

When the shut-off time comes

The receiver turns off automatically.

To check or change the time remaining until the shut-off time

Press SLEEP once.

The remaining time until the shut-off time appears in minutes.

- To change the shut-off time, press SLEEP repeatedly.

To cancel the Sleep Timer

Press SLEEP repeatedly until "SLEEP 00 MIN." appears on the display. (The SLEEP indicator goes off.)

- Turning off the power also cancels the Sleep Timer.

Receiving Radio Broadcasts

You can browse through all the stations or use the preset function to go immediately to a particular station.

Tuning in Stations Manually

On the front panel:

1. Press FM/AM to select the band (FM or AM — MW/LW).

The last received station of the selected band is tuned in.

- Each time you press the button, the band alternates between FM and AM (MW/LW).

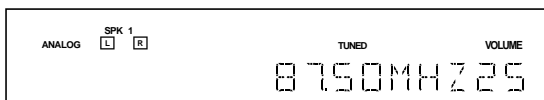
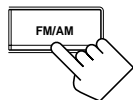

2. Press FM/AM TUNING ▲/▼ until you find the frequency you want.

- Pressing FM/AM TUNING ▲ increases the frequency.
- Pressing FM/AM TUNING ▼ decreases the frequency.

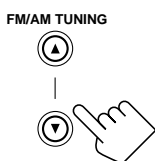

From the remote control:

1. Press FM/AM to select the band.

- Each time you press the button, the band alternates between FM and AM (MW/LW).



2. Press TUNING +/- until you find the frequency you want.

- Pressing TUNING + increases the frequency.
- Pressing TUNING – decreases the frequency.

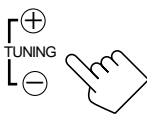

Notes:

- When a station of sufficient signal strength is tuned in, the TUNED indicator lights up on the display.
- When an FM stereo program is received, the STEREO indicator also lights up.

Using Preset Tuning

Once a station is assigned to a channel number, the station can be quickly tuned. You can preset up to 30 FM and 15 AM (MW/LW) stations.

To store the preset stations

Before you start, remember...

- There is a time limit in doing the following steps. If the setting is canceled before you finish, start from step 1 again.

On the front panel ONLY:

1. Tune in the station you want to preset (see “Tuning in Stations Manually”).

- If you want to store the FM reception mode for this station, select the FM reception mode you want. See “Selecting the FM Reception Mode” on page 19.

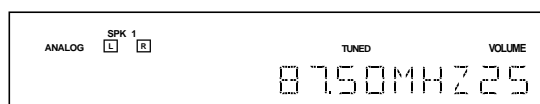

2. Press MEMORY.

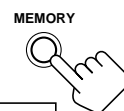

“CH-” appears and the channel number position starts flashing on the display for about 5 seconds.

3. Press FM/AM PRESET ▲/▼ to select a channel number while the channel number position is flashing.

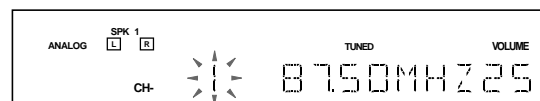
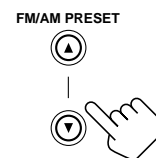

Note:

You can use the 10 keys on the remote control to select the preset number. When using the 10 keys, be sure that they are activated for the tuner, not for the CD and others. (See page 32.)

4. Press MEMORY again while the selected channel number is flashing on the display.

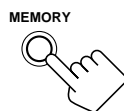

The selected channel number stops flashing.

The station is assigned to the selected channel number.

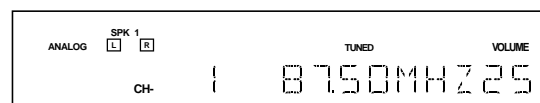

5. Repeat steps 1 to 4 until you store all the stations you want.

To erase a stored preset station

Storing a new station on a used number erases the previously stored one.

To tune in a preset station

On the front panel:

1. Press FM/AM to select the band (FM or AM — MW/LW).
The last received station of the selected band is tuned in.
2. Press FM/AM PRESET ▲/▼ until you find the channel you want.
 - Pressing FM/AM PRESET ▲ increases the channel numbers.
 - Pressing FM/AM PRESET ▼ decreases the channel numbers.

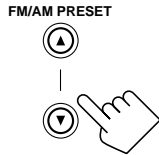
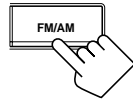

From the remote control:

1. Press FM/AM.
 - Each time you press the button, the band alternates between FM and AM (MW/LW).
2. Press the 10 keys to select a preset channel number.
 - For channel number 5, press 5.
 - For channel number 15, press +10 then 5.
 - For channel number 20, press +10 then 10.
 - For channel number 30, press +10, +10, then 10.

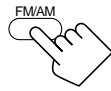

Note:

When you use the 10 keys on the remote control, be sure that they are activated for the tuner, not for the CD and others. (See page 32.)

Selecting the FM Reception Mode

When an FM stereo broadcast is hard to receive or noisy

You can change the FM reception mode while receiving an FM broadcast.

- You can store the FM reception mode for each preset station.

Press FM MODE on the front panel or on the remote control.

- Each time you press the button, the FM reception mode alternates between “AUTO” and “MONO.”

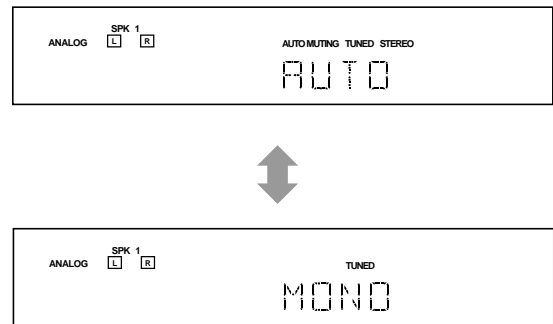
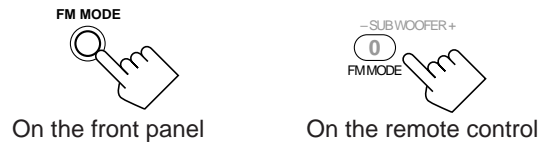

AUTO: When a program is broadcasted in stereo, you will hear stereo sound; when in monaural, you will hear monaural sounds. This mode is also useful to suppress static noise between stations. The AUTO MUTING indicator lights up on the display.

MONO: Reception will be improved although you will lose the stereo effect. In this mode, you will hear noise while tuning into the stations. The AUTO MUTING indicator goes off from the display.

Note:

When using the FM MODE button on the remote control, be sure that the 10 keys are activated for the tuner, not for the CD and others. (See page 32.)

Using the RDS (Radio Data System) to Receive FM Stations

RDS allows FM stations to send an additional signal along with their regular program signals. For example, the stations send their station names, as well as information about what type of program they broadcast, such as sports or music, etc.

When tuned to an FM station which provides the RDS service, the RDS indicator lights up on the display.

With the receiver, you can receive the following types of RDS signals.

PS (Program Service):	Shows commonly known station names
PTY (Program Type):	Shows types of broadcast programs
RT (Radio Text):	Shows text messages the station sends
EON (Enhanced Other Network):	See page 21.

Notes:

- RDS is not available for AM (MW/LW) broadcasts.
- RDS may not operate correctly if the station tuned is not transmitting RDS signal properly or if the signal strength is weak.

What information can RDS signals provide?

You can see the RDS signals the station sends on the display.

To show the RDS signals

Press **DISPLAY MODE** on the front panel or **DISPLAY** on the remote control while listening to an FM station.

DISPLAY MODE



On the front panel



On the remote control

- Each time you press the button, the display changes to show you the following information:

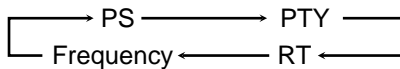

PS (Program Service):

While searching, "PS" appears and then the station names will be displayed. "NO PS" appears if no signal is sent.

PTY (Program Type):

While searching, "PTY" appears and then the type of the broadcast program will be displayed. "NO PTY" appears if no signal is sent.

RT (Radio Text):

While searching, "RT" appears and then text messages the station sends will be displayed. "NO RT" appears if no signal is sent.

Frequency:

Station frequency (non-RDS service)

About characters shown on the display

When the display shows PS, PTY, or RT signals, the following characters are used.

- The display cannot differentiate upper case and lower case letters and always uses upper case letters.
- The display cannot show accented letters, "A," for instance, may stand for accented "A's" like "Ä, Ä, Ä, Á, À, and Â."

Notes:

- When pressing **DISPLAY** on the remote control, make sure that you have selected FM station using the remote control. If not, the **DISPLAY** button does not work for tuner operation. (Pressing **FM/AM** activates the remote control for tuner operation.)
- If searching finishes at once, "PS," "PTY," and "RT" will not appear on the display.

Searching for a Program by PTY Codes

One of the advantages of the RDS service is that you can locate a particular kind of program from the preset channels (see page 18) by specifying the PTY codes.

To search for a program using the PTY codes

Before you start, remember...

- The PTY Search is only applicable to preset stations.
- To stop searching any time during the process, press **PTY SEARCH** while searching.
- There is a time limit in doing the following steps. If the setting is canceled before you finish, start from step 1 again.
- When pressing the buttons on the remote control, make sure that you have selected the FM station using the remote control. If not, the RDS operation buttons do not work for RDS operation. (Pressing **FM/AM** activates the remote control for RDS operation.)

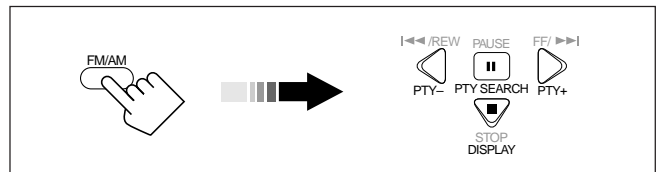

On the front panel:

1. Press **PTY SEARCH** while listening to an FM station.

"PTY SELECT" flashes on the display.

PTY SEARCH



2. Press **CONTROL UP ▲/DOWN ▼** until the PTY code you want appears on the display, while "PTY SELECT" is flashing.

The display gives you the PTY codes described on page 21.

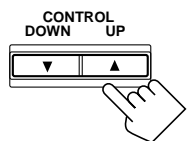

3. Press **PTY SEARCH** again, while the PTY code selected in the previous step is still on the display.

While searching, "SEARCH" and the selected PTY code alternate on the display.

The receiver searches 30 preset FM stations, stops when it finds the one you have selected, and tunes in that station.

PTY SEARCH



To continue searching after the first stop

Press **PTY SEARCH** again while the indications on the display are flashing.

If no program is found, "NOTFOUND" appears on the display.

From the remote control:

1. Press **PTY SEARCH** while listening to an FM station. "PTY SELECT" flashes on the display.



2. Press and hold **PTY +** or **PTY -** until the **PTY** code you want appears on the display, while "PTY SELECT" is flashing.

The display gives you the PTY codes described below.



3. Press **PTY SEARCH** again, while the **PTY** code selected in the previous step is still on the display.

While searching, "SEARCH" and the selected PTY code alternate on the display.

The receiver searches 30 preset FM stations, stops when it finds the one you have selected, and tunes in that station.



To continue searching after the first stop

Press **PTY SEARCH** again while the indications on the display are flashing.

If no program is found, "NOTFOUND" appears on the display.

Switching to a Broadcast Program of Your Choice Temporarily

Another convenient RDS service is called "EON (Enhanced Other Network)."

The EON indicator lights up while receiving an FM station with the EON code. (The EON indicator also lights up while receiving an AM station but the EON function will not work.)

This allows the receiver to switch temporarily to a broadcast program of your choice (NEWS, TA, and/or INFO) from a different station except in the following cases:

- When you are listening to non-RDS stations (all AM — MW/LW and some FM stations).
- When the last received FM station is a non-RDS station.
- When the receiver is in standby mode.

Before you start, remember...

- The EON function is only applicable to preset stations.

On the front panel ONLY:

1. Press **EON** so that the last selected program type appears on the display.



The receiver enters EON standby mode. When the receiver is in EON standby mode, the receiver is ready to receive the EON data (TA/NEWS/INFO) you select.

2. Press **TA/NEWS/INFO** until the program type you want appears on the display.



- Each time you press the button, the display changes to show the following:

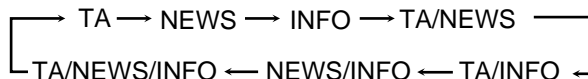

TA: Traffic Announcement in your area.

NEWS: News.

INFO: Program the purpose of which is to impart advice in the widest sense.

PTY codes



CASE 1**If there is no station broadcasting the program you have selected**

The receiver continues playing the current source (all sources except AM — MW/LW).



When a station starts broadcasting the program you have selected, the receiver automatically switches to the station. The indicator of received PTY code starts flashing.



When the program is over, the receiver goes back to the previously selected source, but still remains in EON standby mode. The indicator of received PTY code stops flashing and remains lit.

CASE 2**If there is a station broadcasting the program you have selected**

The receiver changes the source (all sources except AM — MW/LW), and tunes in the station. The indicator of received PTY code starts flashing.



When the program is over, the receiver goes back to the previously selected source, but still remains in EON standby mode. The indicator of received PTY code stops flashing and remains lit.

CASE 3**If the FM station you are listening to is broadcasting the program you have selected**

The receiver continues to receive the station, but the indicator of received PTY code starts flashing.



When the program is over, the indicator of received PTY code stops flashing and remains lit, but the receiver remains in EON standby mode.

When an emergency broadcast (ALARM signal) is sent from an FM station:

The receiver automatically tunes in the station except in the following cases:

- When you are listening to non-RDS stations (all AM — MW/LW and some FM stations).
- When the receiver is in standby mode.

While receiving an emergency broadcast, “ALARM” appears on the display.

The TEST signal is used for equipment test — whether it can receive the ALARM signal correctly.

The TEST signal makes the receiver work in the same way as the ALARM signal does. If the TEST signal is received, the receiver automatically switches to the station broadcasting the TEST signal. While receiving the test signal, “TEST” appears on the display.

Notes:

- EON data sent from some stations may not be compatible with this receiver.
- In EON standby mode, if you carry out synchronized recording (see page 31), EON standby mode is canceled temporarily. The receiver goes back to EON standby mode again when you have finished that operation.
- The EON mode only works when receiving an FM station with the EON code. (The EON indicator lights up while receiving an AM station but the EON function will not work.)
- While listening to a program tuned in by the EON function, you cannot use source selecting buttons and PTY SEARCH button.

CAUTION:

When the source alternates intermittently between the station tuned in by the EON function and the currently selected source, press EON to cancel the EON function.

If you do not press the button, the currently tuned station is received finally, and the indication of the EON program type flashing on the display disappears.

To stop listening to the program selected by EON

Press EON so that the program type (TA/NEWS/INFO) indicator goes off from the display. The receiver enters EON off mode and goes back to the previously selected source.

- Each time you press EON, the EON mode alternates between standby mode and off mode.

Using the DSP Modes

The built-in Surround Processor provides two types of the DSP (Digital Signal Processor) mode — Surround mode and DAP (Digital Acoustic Processor) mode.

What are the DSP Modes?

Surround modes

With this receiver, you can use three types of the Surround mode.

Following modes cannot be used when only the front speakers are connected to this receiver (without the rear speakers or center speaker).

Dolby Surround (Dolby Digital and Dolby Pro Logic)*

Used to watch the soundtracks of software encoded with Dolby Digital (bearing the mark ) or with Dolby Surround (bearing the mark ).

Dolby Surround encoding format records the left front channel, right front channel, center channel, and rear channel (total 4 channels) signals into 2 channels. The Dolby Pro Logic decoder built in this receiver decodes these 2 channel signals into original 4 channel signals — matrix-based multichannel reproduction, and allows you to enjoy the realistic stereo sounds in your listening room.

On the other hand, Dolby Digital encoding method (so called discrete 5.1 channel digital audio format) records and compresses the left front channel, right front channel, center channel, left rear channel, right rear channel, and LFE channel (total 6 channels, but LFE channel is counted as 0.1 channel, therefore called 5.1 channels) signals digitally. Each channel is completely independent from other channel signals to avoid interference, therefore, you can obtain much better sound quality with much stereo and surround effects.

The Dolby Digital decoder built in this receiver can create much more realistic sound field in your listening room. You may feel as if you were in a real theater.

In addition, Dolby Digital enables stereo rear sounds, and sets the cutoff frequency of the rear treble at 20 kHz, compared to 7 kHz for Dolby Pro Logic. These facts enhance the sound movement and being-there feelings much more than Dolby Pro Logic.

- To enjoy the software encoded with Dolby Digital, you must connect the source component using the digital terminal on the rear of this receiver. (See page 8.)

DTS Digital Surround**

DTS Digital Surround is another discrete 5.1 channel digital audio format available on CD, LD, and DVD software.

Compared to Dolby Digital, audio compression rate is relatively low. This fact allows DTS Digital Surround format to add breadth and depth to the reproduced sounds. As a result, DTS Digital Surround features natural, solid and clear sound.

- To enjoy the software encoded with DTS Digital Surround, you must connect the source component using the digital terminal on the rear of this receiver. (See page 8.)

JVC Theater Surround

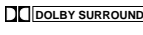
In order to reproduce a more realistic sound field in your listening room while playing soundtracks of software encoded with Dolby Surround (bearing the mark ) , you can use JVC Theater Surround.

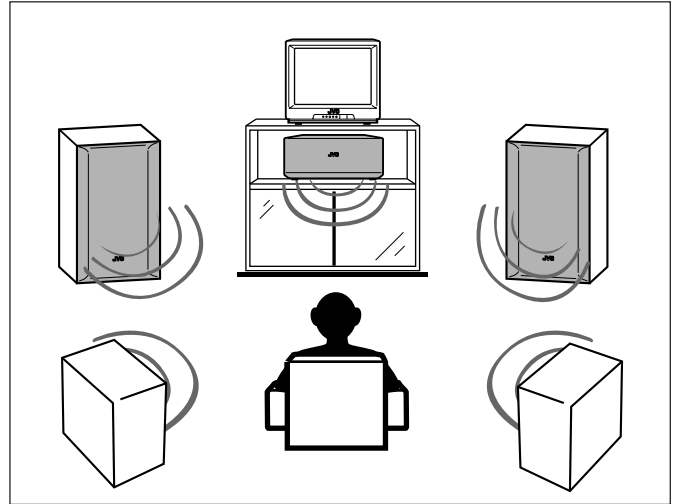

Notes:

- The DSP modes have no effect on monaural sources.
- When you select "DVD MULTI" as the source to play, you cannot select or adjust the DSP modes.
- The PRO LOGIC indicator lights up when the Dolby Pro Logic decoder built in this receiver is activated.

* Manufactured under license from Dolby Laboratories. "Dolby," "Pro Logic," and the double-D symbol are trademarks of Dolby Laboratories. Confidential Unpublished Works. ©1992–1997 Dolby Laboratories, Inc. All rights reserved.

** Manufactured under license from Digital Theater Systems, Inc. US Pat. No. 5,451,942 and other world-wide patents issues and pending. "DTS" and "DTS Digital Surround" are trademarks of Digital Theater Systems, Inc. ©1996 Digital Theater Systems, Inc. All rights reserved.

DAP modes

In order to reproduce a more acoustic sound field in your listening room while playing soundtracks of stereo sources, you can use DAP modes. **This mode can be used when the front speakers and the rear speakers are connected to this receiver (without respect to the center speaker connection).**

You can select one of the following to your preference.

LIVE CLUB:	Gives the feeling of a live music club with a low ceiling.
DANCE CLUB:	Gives a throbbing bass beat.
HALL:	Gives clear vocal and the feeling of a concert hall.
PAVILION:	Gives the spacious feeling of a pavilion with a high ceiling.

DVD MULTI Playback Mode

This receiver provides the DVD MULTI playback mode for reproducing the analog discrete 5.1 channel output mode of the DVD player or other equipment.

You can adjust the DVD MULTI playback mode while playing back a video software such as a DVD using the analog discrete 5.1 channel output mode.

- For the DVD MULTI playback mode connection, see page 7.
- For details on the DVD MULTI playback mode, see page 30.

Reproducing the Sound Field

The sound heard in a concert hall or club consists of direct sound and indirect sound — early reflections and reflections from behind. Direct sounds reach the listener directly without any reflection. On the other hand, indirect sounds are delayed by the distances of the ceiling and walls. These direct sounds and indirect sounds are the most important elements of the acoustic surround effects.

JVC Theater Surround and DAP modes can create these important elements, and give you a real “being there” feeling.

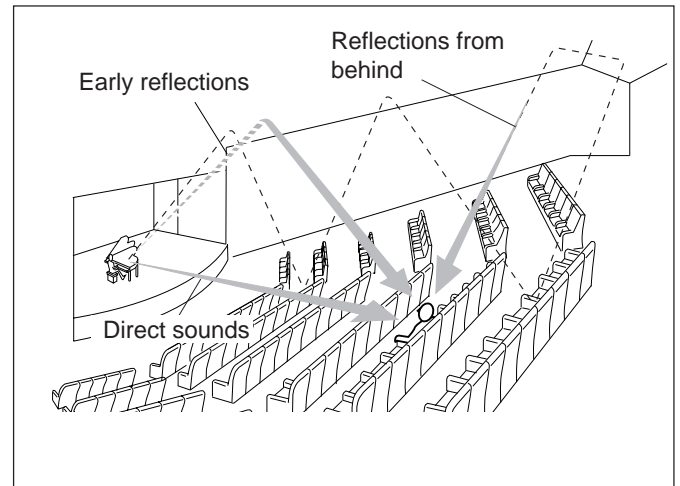

Available DSP modes according to the input mode

○: Possible ×: Impossible

BUTTON		SURROUND ON/OFF	DSP MODE					
MODE		SURROUND ON	THEATER	LIVE CLUB	DANCE CLUB	HALL	PAVILION	DSP OFF (SURROUND OFF)
INPUT	ANALOG (2 CH)	○ (DOLBY PRO LOGIC)	○	○	○	○	○	○
	DVD MULTI (ANALOG 5.1 CH)	×	×	×	×	×	×	×
	LINEAR PCM	○ (DOLBY PRO LOGIC)	○	○	○	○	○	○
	DOLBY DIGITAL	○ *1 (DOLBY DIGITAL)	×	×	×	×	×	○
	DTS	○ *2 (DTS SURROUND)	×	×	×	×	×	○

*1 When 2 channel signal comes in, DOLBY PRO LOGIC is selected. When other signals come in, DOLBY DIGITAL is selected.

*2 When 2 channel signal comes in, DOLBY PRO LOGIC is selected. When other signals come in, DTS SURROUND is selected.

Available DSP Modes According to the Speaker Arrangement

Available DSP modes will vary depending on how many speakers are used with this receiver.

Make sure that you have set the speaker information correctly (see page 14).

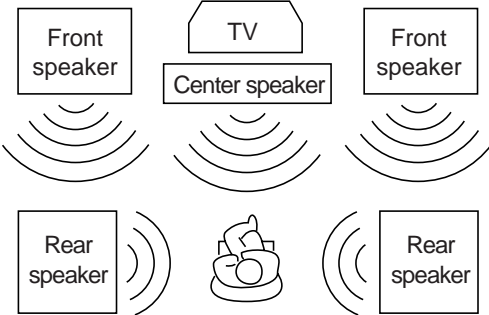
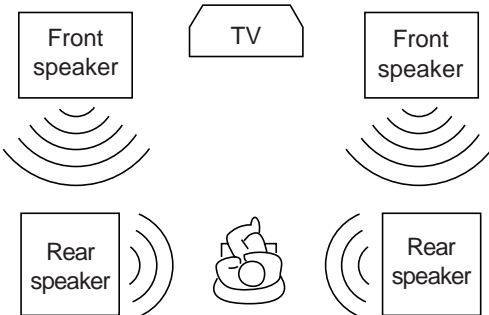
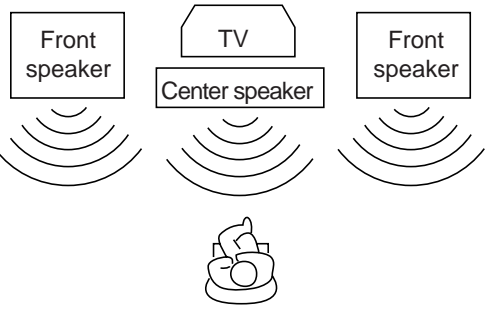
Speaker arrangements	Available DSP modes	
	<p>By pressing SURROUND ON/OFF, the surround mode turns on and off:</p> <ul style="list-style-type: none"> • SURROUND ON (PRO LOGIC, DOLBY DIGITAL or DTS SURROUND) • SURROUND OFF (DSP mode is canceled) 	<p>By pressing DSP MODE, the DSP modes change as follows:</p> <ul style="list-style-type: none"> • THEATER • LIVE CLUB • DANCE CLUB • HALL • PAVILION • DSP OFF (DSP mode is canceled)
		
	<p>By pressing SURROUND ON/OFF, the surround mode turns on and off:</p> <ul style="list-style-type: none"> • SURROUND ON (PRO LOGIC, DOLBY DIGITAL or DTS SURROUND) • SURROUND OFF (DSP mode is canceled) 	<p>By pressing DSP MODE, the DSP modes change as follows:</p> <ul style="list-style-type: none"> • THEATER • DSP OFF (DSP mode is canceled)

Adjusting the Surround Modes

Once you have adjusted the Surround modes, the adjustment is memorized for each Surround mode.



Dolby and DTS Surround adjustments

Before you start, remember...

- Make sure that you have set the speaker information correctly (see page 14).
- There is a time limit in doing the following steps. If the setting is canceled before you finish, start from step 3 again.
- You cannot adjust the rear speaker output levels when you have set "REAR SPK" to "NO." See page 14.
- You cannot adjust the center speaker output level when you have set "CENTER SPK" to "NO." See page 14.

From the remote control:

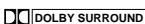
1. Select and play a sound source.

- To enjoy Dolby Pro Logic, play back a software encoded with Dolby Surround and labeled with  mark.
- To enjoy Dolby Digital, play back a software encoded with Dolby Digital and labeled with  mark.
- To enjoy DTS Digital Surround, play back a software encoded with DTS Digital Surround and labeled with  mark.

2. Press SURROUND ON/OFF to activate an appropriate Surround mode — PRO LOGIC, DOLBY DIGITAL or DTS SURROUND.



When "PRO LOGIC" is selected, the PRO LOGIC indicator lights up on the display.

- Each time you press the button, the Surround mode turns on and off alternately.

3. Press SOUND.

The 10 keys are activated for sound adjustments.

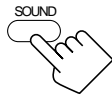

4. Press TEST to check the speaker output balance.

"TEST TONE L" starts flashing on the display, and a test tone comes out of the speakers in the following order:

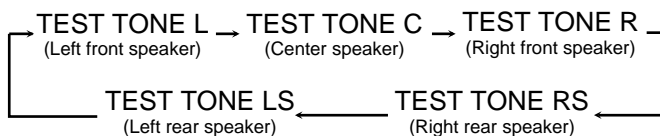
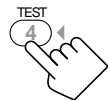

Notes:

- You can adjust the speaker output levels without outputting the test tone.
- No test tone comes out of the center speaker when "CENTER SPK" is set to "NO" (see page 14).
- No test tone comes out of the rear speakers when "REAR SPK" is set to "NO" (see page 14).

5. Adjust the speaker output levels.

- To adjust the center speaker level, press CENTER +/- (from +10 dB to -10 dB).
- To adjust the left rear speaker level, press REAR•L +/- (from +10 dB to -10 dB).
- To adjust the right rear speaker level, press REAR•R +/- (from +10 dB to -10 dB).

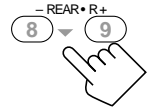
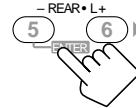
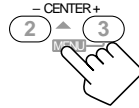

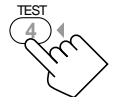

6. Press TEST again to stop the test tone.



On the front panel:

You can also use the buttons on the front panel to adjust the Surround modes. However, no test tone is available when using the buttons on the front panel. So, make adjustments while listening to the sound of the source played back.

1. Select and play a sound source.

- To enjoy Dolby Pro Logic, play back a software encoded with Dolby Surround and labeled with  mark.
- To enjoy Dolby Digital, play back a software encoded with Dolby Digital and labeled with  mark.
- To enjoy DTS Digital Surround, play back a software encoded with DTS Digital Surround and labeled with  mark.

2. Press SURROUND ON/OFF to activate an appropriate Surround mode — PRO LOGIC, DOLBY DIGITAL or DTS SURROUND.

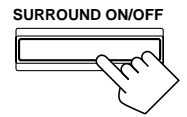

When "PRO LOGIC" is selected, the PRO LOGIC indicator lights up on the display.

- Each time you press the button, the Surround mode turns on and off alternately.

3. Adjust the speaker output levels.

- 1) Press ADJUST repeatedly until one of the following indications appears on the display.

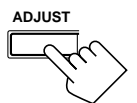

"CENTER LEVEL":

To adjust the center speaker level.

"REAR L LEVEL":

To adjust the left rear speaker level.

"REAR R LEVEL":

To adjust the right rear speaker level.

- 2) Press CONTROL UP ▲/DOWN ▼ to adjust the selected speaker output level (from +10 dB to -10 dB).

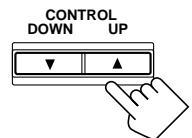

- 3) Repeat 1) and 2) to adjust the other speaker output levels.

JVC Theater Surround adjustments

Before you start, remember...

- Make sure that you have set the speaker information correctly (see page 14).
- There is a time limit in doing the following steps. If the setting is canceled before you finish, start from step 2 again.
- You cannot adjust the rear speaker output levels when you have set "REAR SPK" to "NO." See page 14.
- You cannot adjust the center speaker output level when you have set "CENTER SPK" to "NO." See page 14.

From the remote control:

1. Press DSP MODE repeatedly until "THEATER" appears on the display.

The PRO LOGIC and DSP indicators also light up on the display.



2. Press SOUND.

The 10 keys are activated for sound adjustments.

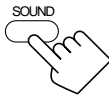

3. Press TEST to check the speaker output balance.

"TEST TONE L" starts flashing on the display, and a test tone comes out of the speakers in the following order:

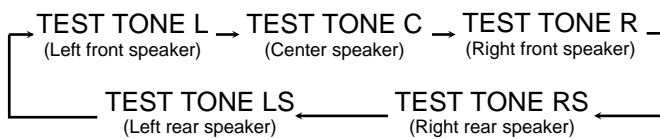

Notes:

- You can adjust the speaker output levels without outputting the test tone.
- No test tone comes out of the center speaker when "CENTER SPK" is set to "NO" (see page 14).
- No test tone comes out of the rear speakers when "REAR SPK" is set to "NO" (see page 14).

4. Adjust the speaker output levels.

- To adjust the center speaker level, press CENTER +/- (from +10 dB to -10 dB).
- To adjust the left rear speaker level, press REAR•L +/- (from +10 dB to -10 dB).
- To adjust the right rear speaker level, press REAR•R +/- (from +10 dB to -10 dB).

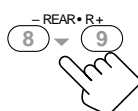
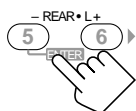
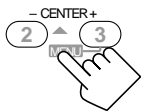

5. Press TEST again to stop the test tone.

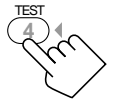

6. Press EFFECT to select an effect level you want.

- Each time you press the button, the effect level changes as follows:

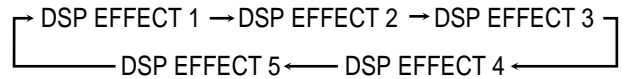
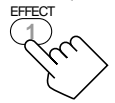

As the number increases, JVC Theater Surround becomes stronger (normally set it to "DSP EFFECT 3").

On the front panel:

You can also use the buttons on the front panel to adjust the Surround modes. However, no test tone is available when using the buttons on the front panel. So, make adjustments while listening to the sound of the source played back.

1. Press DSP MODE repeatedly until "THEATER" appears on the display.

The PRO LOGIC and DSP indicators also light up on the display.

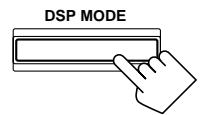

2. Adjust the speaker output levels.

- 1) Press ADJUST repeatedly until one of the following indications appears on the display.

"CENTER LEVEL":

To adjust the center speaker level.

"REAR L LEVEL":

To adjust the left rear speaker level.

"REAR R LEVEL":

To adjust the right rear speaker level.

- 2) Press CONTROL UP ▲/DOWN ▼ to adjust the selected speaker output level (from +10 dB to -10 dB).

- 3) Repeat 1) and 2) to adjust the other speaker output levels.

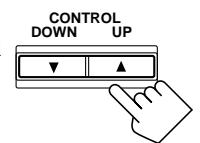
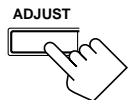

3. Adjust the effect level.

- 1) Press ADJUST repeatedly until "DSP EFFECT" appears on the display.

The display changes to show the current setting.

- 2) Press CONTROL UP ▲/DOWN ▼ to select the effect level.

- Each time you press the button, the effect level changes as follows:

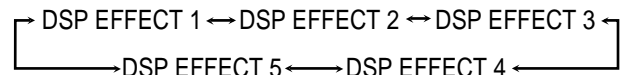
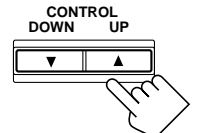
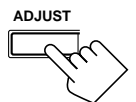

As the number increases, JVC Theater Surround becomes stronger (normally set it to "DSP EFFECT 3").

Adjusting the DAP Modes

Once you have adjusted the DAP modes, the adjustment is memorized for each DAP mode.

Before you start, remember...

- Make sure that you have set the speaker information correctly (see page 14).
- There is a time limit in doing the following steps. If the setting is canceled before you finish, start from step 1 again.
- You cannot adjust the rear speaker output level when you have set "REAR SPK" to "NO." See page 14.

On the front panel:

1. Press **DSP MODE** repeatedly until the DAP mode — **LIVE CLUB, DANCE CLUB, HALL, or PAVILION** — appears on the display.

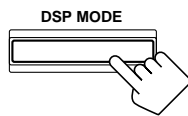

The DSP indicator also lights up on the display.

2. Adjust the rear speaker output levels.

- 1) Press **ADJUST** repeatedly until one of the following indications appears on the display.

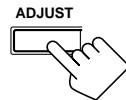

"REAR L LEVEL":

To adjust the left rear speaker level.

"REAR R LEVEL":

To adjust the right rear speaker level.

- 2) Press **CONTROL UP ▲/DOWN ▼** to adjust the selected speaker output level (from +10 dB to -10 dB).

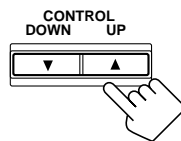

- 3) Repeat 1) and 2) to adjust the other speaker output level.

3. Adjust the effect level.

- 1) Press **ADJUST** repeatedly until "DSP EFFECT" appears on the display.

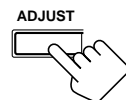

The display changes to show the current setting.

- 2) Press **CONTROL UP ▲/DOWN ▼** to select the effect level.

- Each time you press the button, the effect level changes as follows:

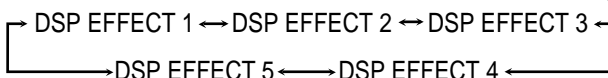
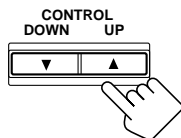

As the number increases, the selected DAP mode becomes stronger (normally set it to "DSP EFFECT 3").

From the remote control:

1. Press **DSP MODE** repeatedly until the DAP mode — **LIVE CLUB, DANCE CLUB, HALL, or PAVILION** — appears on the display.

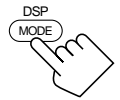

The DSP indicator also lights up on the display.

2. Press **SOUND**.

The 10 keys are activated for sound adjustments.

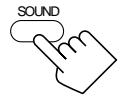

3. Adjust the rear speaker output levels.

- To adjust the left rear speaker level, press REAR•L +/- (from +10 dB to -10 dB).
- To adjust the right rear speaker level, press REAR•R +/- (from +10 dB to -10 dB).

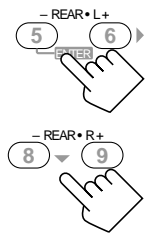

4. Press **EFFECT** to select an effect level you want.

- Each time you press the button, the effect level changes as follows:

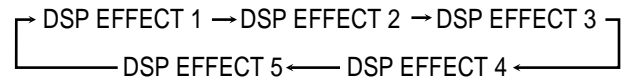
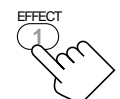

As the number increases, the selected DAP mode becomes stronger (normally set it to "DSP EFFECT 3").

Activating the DSP Modes

You can use only one DSP mode at a time. When a DSP mode is activated, another DSP mode is canceled if in use.

For Dolby Pro Logic, Dolby Digital, and DTS Digital Surround

1. Press SURROUND ON/OFF.

- Each time you press the button, the Dolby/DTS Surround turns on and off alternately.

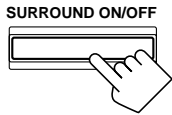



On the front panel

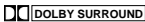

On the remote control

2. Select and play a sound source.

- To enjoy Dolby Pro Logic, play back a software encoded with Dolby Surround and labeled with  mark.
- To enjoy Dolby Digital, play back a software encoded with Dolby Digital and labeled with  mark.
- To enjoy DTS Digital Surround, play back a software encoded with DTS Digital Surround and labeled with  mark.

To cancel the Dolby/DTS Surround mode

Press SURROUND ON/OFF again. (“SURROUND OFF” appears on the display.)

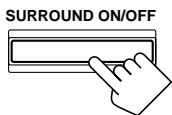

On the front panel



On the remote control

For the other DSP modes

1. Press DSP MODE repeatedly until the mode you want appears on the display.

- Each time you press the button, the DSP modes change. (See page 25 for more details.)

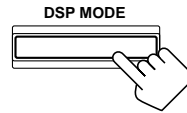

On the front panel



On the remote control

2. Select and play a sound source.

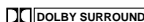
- To enjoy JVC Theater Surround, play back a software encoded with Dolby Surround and labeled with  mark.

To cancel the DSP mode

Press DSP MODE repeatedly until “DSP OFF” appears on the display.

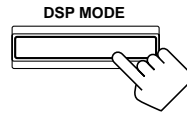

On the front panel



On the remote control

Using the DVD MULTI Playback Mode

This receiver provides the DVD MULTI playback mode for reproducing the analog discrete output mode of the DVD player. Before playing back a DVD, refer also to the manual supplied with the DVD player.

Activating the DVD MULTI Playback Mode

You can adjust the DVD MULTI playback mode while playing back a DVD using the analog discrete output mode on the DVD player. Once you have made adjustments, the receiver memorizes the adjustments until you change them. You also need to set the DVD player to the analog discrete output mode.

Before you start, remember...

- There is a time limit in doing the following steps. If the setting is canceled before you finish, start from step 1 again.

On the front panel:

1. Press DVD MULTI so that “DVD MULTI” appears on the display.



Note:

When you select “DVD MULTI” as the source to play, the DSP mode is canceled, and the SURROUND ON/OFF and DSP MODE buttons do not work.

2. Select the analog discrete output mode on the DVD player, and start playing a DVD.

- Refer to the manual supplied with the DVD player.

If you need to make any adjustment, go to the following steps.

3. Adjust the speaker output levels.

- 1) Press ADJUST repeatedly until one of the following indications appears on the display.

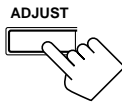

“CENTER LEVEL”:

To adjust the center speaker level.

“REAR L LEVEL”:

To adjust the left rear speaker level.

“REAR R LEVEL”:

To adjust the right rear speaker level.

- 2) Press CONTROL UP ▲/DOWN ▼ to adjust the selected speaker output level (from +10 dB to -10 dB).

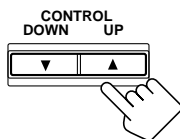

- 3) Repeat 1) and 2) to adjust the other speaker output levels.

From the remote control:

1. Press DVD MULTI so that “DVD MULTI” appears on the display.



Note:

When you select “DVD MULTI” as the source to play, the DSP mode is canceled, and the SURROUND ON/OFF and DSP MODE buttons do not work.

2. Select the analog discrete output mode on the DVD player, and start playing a DVD.

- Refer to the manual supplied with the DVD player.

If you need to make any adjustment, go to the following steps.

3. Press SOUND.

The 10 keys are activated for adjusting the sound.

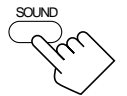

4. Adjust the speaker output levels.

- To adjust the center speaker level, press CENTER +/- (from +10 dB to -10 dB).
- To adjust the left rear speaker level, press REAR•L +/- (from +10 dB to -10 dB).
- To adjust the right rear speaker level, press REAR•R +/- (from +10 dB to -10 dB).

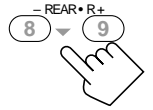
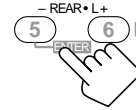
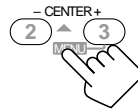

COMPU LINK Remote Control System

The COMPU LINK remote control system allows you to operate JVC audio components through the remote sensor on the receiver.

To use this remote control system, you need to connect JVC audio components through the COMPU LINK (SYNCHRO) jacks (see below) in addition to the connections using cables with RCA pin plugs (see pages 5 and 6).

- Make sure that the AC power cords of these components are unplugged before connection. Plug the AC power cords only after all connections are complete.

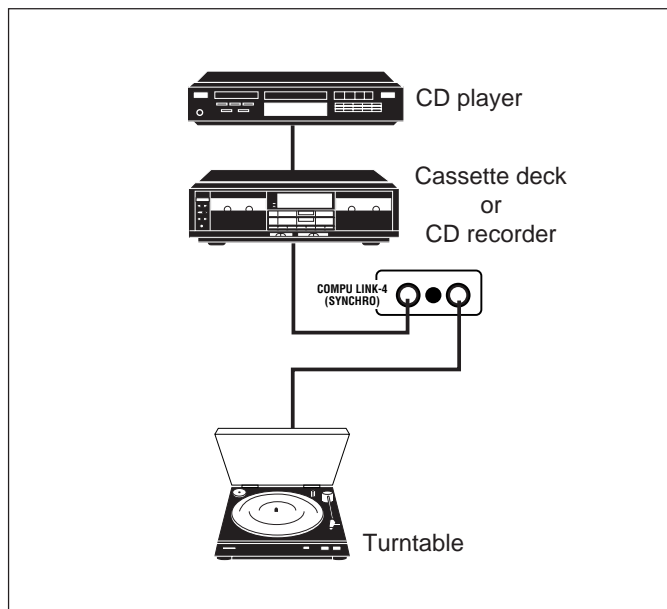

Notes:

- There are four versions of COMPU LINK remote control system. This receiver is equipped with the fourth version — COMPU LINK-4. This version is added systematic operations with the CD recorder to the previous version — COMPU LINK-3.
- If your audio component has two COMPU LINK jacks, you can use either one. If it has only one COMPU LINK jack, connect it so that it is the last item in the series of components. (For example, the turntable or CD player in the diagram above.)
- To operate the cassette deck or CD recorder using the COMPU LINK remote control system, set the source name correctly. (See page 13.)
- Refer also to the manuals supplied with your audio components.

This remote control system allows you to use four functions listed below.

Remote Control through the Remote Sensor on the Receiver

You can control the connected audio components through the remote sensor on the receiver using this remote control. Aim the remote control directly at the remote sensor on the receiver. For details, see pages 32 and 33.

Automatic Source Selection

When you press the play (▶) button on a connected component or on its own remote control, the receiver automatically turns on and changes the source to the component. On the other hand, if you select a new source on the receiver or on the remote control, the selected component begins playing immediately.

In both cases, the previously selected source continues playing without sound for a few seconds.

Automatic Power On/Off (Standby): only possible with the COMPU LINK-3 and COMPU LINK-4 connection

The connected components turn on and off (standby) along with the receiver.

When you turn on the receiver, one of the connected component will turn on automatically, depending on which component has been previously selected.

When you turn off the receiver, the connected components will turn off (standby).

Synchronized Recording

Synchronized recording means the cassette deck starts recording as soon as a CD or a record begins playing.

To use synchronized recording, follow these steps:

1. Put a tape in the cassette deck, and a disc in the CD player (or a record on the turntable).
2. Press the record (●) button and the pause (II) button on the cassette deck at the same time.

This puts the cassette deck into recording pause.

If you do not press the record (●) button and pause (II) button at the same time, the synchronized recording feature will not operate.

3. Press the play (▶) button on the CD player or on the turntable.

The source changes on the receiver, and as soon as play starts, the cassette deck starts recording. When the play ends, the cassette deck enters recording pause, and stops about 4 seconds later.

Notes:

- During synchronized recording, the selected source cannot be changed.
- If the power of any component is shut off during synchronized recording, the COMPU LINK remote control system may not operate properly. In this case, you must start again from the beginning.

Operating JVC's Audio/Video Components

You can operate JVC's audio and video components with this receiver's remote control, since control signals for JVC components are preset in the remote control.

Operating Audio Components

IMPORTANT:

To operate JVC's audio components using this remote control:

- You need to connect JVC audio components through the COMPU LINK (SYNCHRO) jacks (see page 31) in addition to the connections using cables with RCA pin plugs (see pages 5 and 6).
- Aim the remote control directly at the remote sensor on the receiver.
- If you use the buttons on the front panel, the remote control will not operate that source. To operate a source with the remote control, the source must be selected using source selecting buttons on the remote control.
- To operate the cassette deck or CD recorder using the COMPU LINK remote control system, set the source name correctly. (See page 13.)
- Refer also to the manuals supplied with your components.

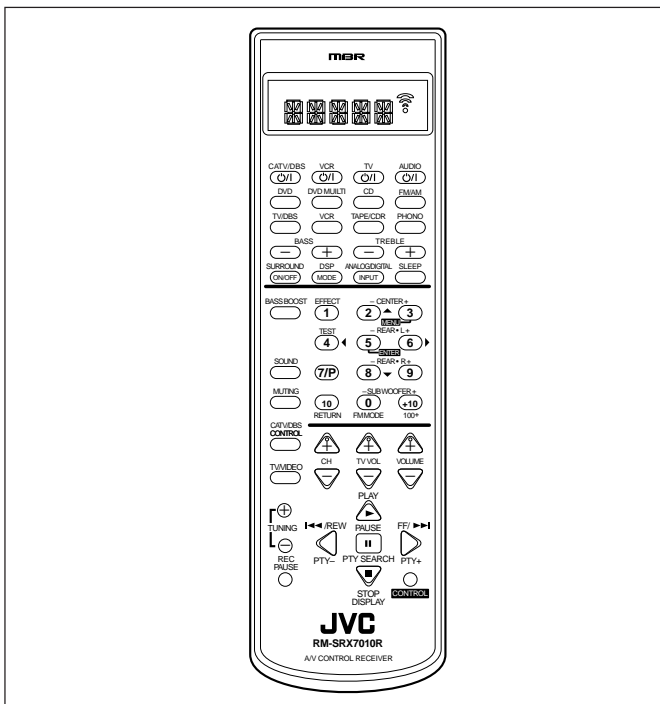

* When you press one of the following buttons, the remote control operation mode appears on the display window for about 10 seconds.

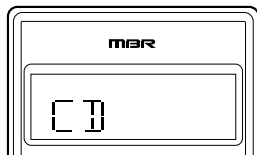

Ex.: When you press CD button

Buttons on the Remote Control	Remote Control Operation Mode
FM/AM	TUNER
CD	CD
PHONO	PHONO
TAPE/CDR	TAPE
DVD	DVD
DVD MULTI	DVD
TV/DBS	TV
VCR	VCR
CATV/DBS CONTROL	DBS
CONTROL	Current setting or VCR or TAPE or CDDSC
SOUND	SOUND

Tuner

You can always perform the following operations:

FM/AM: Alternates between FM and AM (MW/LW).

After pressing FM/AM, you can perform the following operations:

1 – 10, +10: Selects a preset channel number directly.
 For channel number 5, press 5.
 For channel number 15, press +10, then 5.
 For channel number 20, press +10, then 10.

TUNING +/-: Tunes into stations.

FM MODE: Changes the FM reception mode.

PTY SEARCH: Searches for a program by PTY codes.

PTY +/-: Selects the PTY codes.

DISPLAY: Shows the RDS signals.

Sound control section (Amplifier)

You can always perform the following operations:

SURROUND ON/OFF: Turns on or off the Surround modes – Dolby Pro Logic, Dolby Digital, and DTS Digital Surround.

DSP MODE: Selects the DSP modes.

After pressing SOUND, you can perform the following operations:

SUBWOOFER +/-: Adjusts the subwoofer output level.

CENTER +/-: Adjusts the center speaker output level.

REAR•L +/-: Adjusts the left rear speaker output level.

REAR•R +/-: Adjusts the right rear speaker output level.

EFFECT: Selects the effect level.

TEST: Turns on or off the test tone output.

Note:

After adjusting sounds, press the corresponding source selecting button to operate your target source by using the 10 keys; otherwise, the 10 keys cannot be used for operating your target source.

CD player

After pressing CD, you can perform the following operations on the CD player:

PLAY▶: Starts playing.

◀◀: Returns to the beginning of the current (or previous) track.

▶▶: Skips to the beginning of the next track.

STOP■: Stops playing.

PAUSE||: Pauses playing. To release it, press PLAY▶.

1 – 10, +10: Selects a track number directly.

For track number 5, press 5.

For track number 15, press +10, then 5.

For track number 20, press +10, then 10.

For track number 30, press +10, +10, then 10.

CD changer

After pressing CONTROL repeatedly until “CDDSC” appears on the display window, you can perform the following operations on the CD changer:

- PLAY▶: Starts playing.
- ◀◀: Returns to the beginning of the current (or previous) track.
- ▶▶: Skips to the beginning of the next track.
- STOP■: Stops playing.
- PAUSE▬: Pauses playing. To release it, press PLAY▶.
- 1 – 6, 7/P: Selects the number of a disc installed in a CD changer.

After pressing CD, you can perform the following operations on the CD changer:

- 1 – 10, +10: Selects a track number directly.
 - For track number 5, press 5.
 - For track number 15, press +10, then 5.
 - For track number 20, press +10, then 10.
 - For track number 30, press +10, +10, then 10.

EXAMPLE:

- Selecting disc number 4, track number 12, and starting playback.
 1. Press CONTROL repeatedly until “CDDSC” appears on the display window, then press 4.
 2. Press CD, then press +10, 2.

Turntable

After pressing PHONO, you can perform the following operations on a turntable:

- PLAY▶: Starts playing.
- STOP■: Stops operations.

Cassette deck

After pressing TAPE/CDR (or CONTROL repeatedly until “TAPE” appears on the display window), you can perform the following operations on a cassette deck:

- PLAY▶: Starts playing.
- REW: Fast winds the tape from right to left.
- FF: Fast winds the tape from left to right.
- STOP■: Stops operations.
- PAUSE▬: Pauses playing. To release it, press PLAY▶.
- REC PAUSE: Starts recording or enters recording pause.

CD recorder

After pressing TAPE/CDR (or CONTROL repeatedly until “TAPE” appears on the display window), you can perform the following operations on the CD recorder:

- PLAY▶: Starts playing.
- ◀◀: Returns to the beginning of the current (or previous) track.
- ▶▶: Skips to the beginning of the next track.
- STOP■: Stops playing.
- PAUSE▬: Pauses playing. To release it, press PLAY▶.
- REC PAUSE: Starts recording or enters recording pause.

Note:

You can use either TAPE/CDR button or CONTROL button to activate the buttons listed above. If you press TAPE/CDR, the playing source also changes. On the other hand, if you press CONTROL repeatedly to select “TAPE,” the playing source does not change.

Operating Video Components

IMPORTANT:

To operate JVC's video components using this remote control:

- Some JVC VCRs can accept two types of the control signals — remote code “A” and “B.” Before using this remote control, make sure that the remote control code of the VCR connected to the VCR jacks is set to code “A.”
- When using the remote control:
 - For the DVD player, TV, and VCR operations, aim the remote control directly at the remote sensor on each component, not on the receiver.

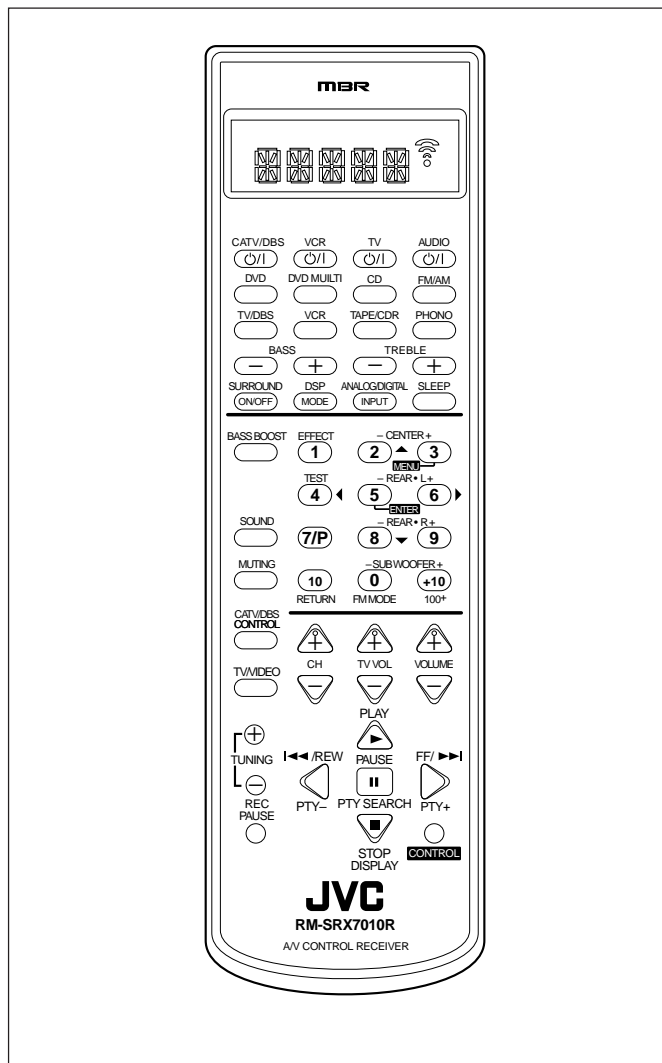

VCR

You can always perform the following operations:

VCR \odot/I : Turns on or off the VCR.

After pressing VCR (or CONTROL repeatedly until “VCR” appears on the display window), you can perform the following operations on the VCR:

- 1 – 9, 0: Selects the TV channels on VCR.
- PLAY \blacktriangleright : Starts playing.
- REW: Rewinds a tape.
- FF: Fast winds a tape.
- STOP \blacksquare : Stops operations.
- PAUSE II : Pauses playing. To release it, press PLAY \blacktriangleright .
- REC PAUSE: Starts recording or enters recording pause.
- CH +/-: Changes the TV channels on the VCR.

Note:

You can use either VCR button or CONTROL button to activate the buttons listed above. If you press VCR, the playing source also changes. On the other hand, if you press CONTROL repeatedly to select “VCR,” the playing source does not change.

DVD player

After pressing DVD or DVD MULTI, you can perform the following operations on a DVD player:

- PLAY \blacktriangleright : Starts playing.
- \lll : Returns to the beginning of the current (or previous) track.
- \ggg : Skips to the beginning of the next track.
- STOP \blacksquare : Stops playing.
- PAUSE II : Stops playing temporarily. To release it, press PLAY \blacktriangleright .

After pressing DVD or DVD MULTI, these buttons can be used for the DVD menu operations.

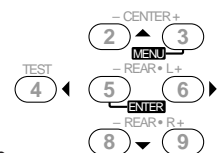

Note:

For detailed menu operations, refer to the instructions supplied with the discs or the DVD player.

TV

You can always perform the following operations:

- TV \odot/I : Turns on or off the TV.
- TV VOL +/-: Adjusts the volume.
- TV/VIDEO: Sets the input mode (either TV or VIDEO).

After pressing TV/DBS, you can perform the following operations on a TV:

- CH +/-: Changes the channels.
- 1 – 9, 0, 100+: Selects the channels.
- RETURN: Alternates between the previously selected channel and the current channel.

Operating Other Manufacturers' Video Equipment

This remote control supplied with the receiver can transmit control signals for other manufacturers' VCRs, TVs, CATV converters, DBS tuners, and DVD players. By changing the transmittable signals from preset ones to the other manufacturers', you can operate the other manufacturer's components using this remote control.

When operating the other manufacturers' components, refer also to the manuals supplied with them. To operate these components with the remote control, first you need to set the manufacturer's code each for VCR, TV, CATV converters, DBS tuner, and DVD player.

When replacing batteries of the remote control, set the manufacturers' codes again.

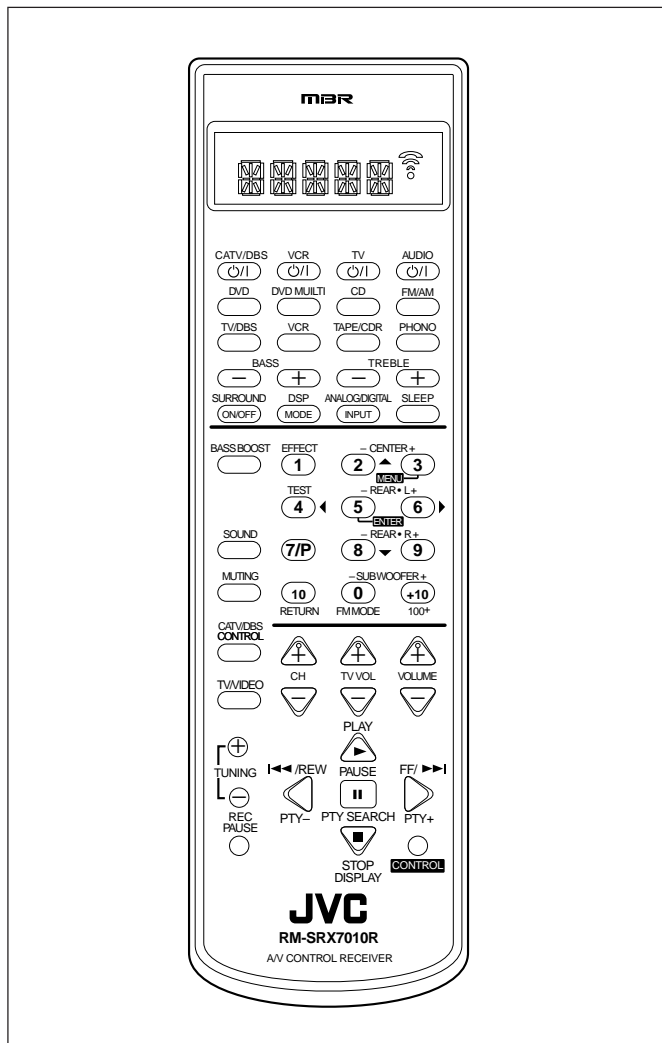

Manufacturers' codes are subject to change without notice. If they are changed, this remote control cannot operate the equipment.

To change the transmittable signals for operating another manufacturer's TV

1. Press and hold TV \odot /I.
2. Press TV/DBS.
3. Enter manufacturer's code using buttons 1-9, and 0.

See the list below to find the code.

4. Release TV \odot /I.

The following buttons can be used for operating the TV:

TV \odot /I: Turns on and off the TV.
 TV VOL +/-: Adjusts the volume.
 TV/VIDEO: Sets the input mode (either TV or VIDEO).

After pressing TV/DBS, you can perform the following operations on a TV:

CH +/-: Changes the channels.
 1 - 10, 0, 100+ (+10): Selects the channels.
 The 10 button will function as the ENTER button if your TV requires pressing ENTER after selecting a channel number.

Note:

Refer to the manual supplied with your TV.

5. Try to operate your TV by pressing TV \odot /I.

When your TV turns on or off, you have entered the correct code.

If there are more than one code listed for your brand of TV, try each one until the correct one is entered.

Manufacturer	Codes
JVC	00, 02, 13, 14, 47, 74
AKAI	01, 02
BLAUPUNKT	03, 04
FISHER	01, 05
GRUNDIG	03, 06, 07
HITACHI	08, 09, 10, 49
IRADDIO	02
ITT/NOKIA	11, 12
LOEWE	06, 15, 16
MAGNAVOX	08, 17, 49
METS	50, 51, 52, 53
MITSUBISHI	08, 18, 19, 20
MIVAR	21
NORDMENDE	22, 23
OKANO	15
PANASONIC	24, 25, 26, 27, 76
PHILIPS	15, 17, 28, 75
QUELLE	52, 53, 54, 55, 56, 57, 58, 59, 60, 61, 62, 63, 64, 65, 66, 67
RCA/PROSCAN	08, 24, 29, 30, 31, 48
SABA	32, 33, 68, 69, 70
SAMSUNG	06, 08, 16, 34, 35, 49
SANYO	01, 05
SCHNEIDER	02, 15, 36
SHARP	37, 38, 77
SONY	39
TELEFUNKEN	40, 41, 42, 69
THOMSON	71, 72
TOSHIBA	37, 43, 44
ZENITH	45, 46

To change the transmittable signals for operating a CATV converter or DBS tuner

1. Press and hold CATV/DBS $\odot/|$.
2. Press CATV/DBS CONTROL.
3. Enter manufacturer's code using buttons 1–9, and 0.

See the list to the right to find the code.

4. Release CATV/DBS $\odot/|$.

The following buttons can be used for operating the CATV converter or DBS tuner:

CATV/DBS $\odot/|$: Turns on and off the CATV converter or DBS tuner.

CH +/-: Changes the channels.

1 – 10, 0, 100+ (+10): Selects the channels. The 10 button will function as the ENTER button if your equipment requires pressing ENTER after selecting a channel number.

Note:

Refer to the manual supplied with your CATV converter or DBS tuner.

5. Try to operate your CATV converter or DBS tuner by pressing CATV/DBS $\odot/|$.

When your CATV converter or DBS tuner turns on or off, you have entered the correct code.

If there are more than one code listed for your brand of CATV converter or DBS tuner, try each one until the correct one is entered.

Note:

You cannot use both the CATV converter and DBS tuner at the same time.

For CATV converter

Manufacturer	Codes
GENERAL INSTRUMENT	06, 07, 08, 09, 10, 11, 12, 13, 14, 29
HAMLIN/REGAL	01, 02, 03, 04, 05
JERROLD	06, 07, 08, 09, 10, 11, 12, 13, 14
OAK	15, 16, 17
PANASONIC	18, 19, 20
PIONEER	21, 22
SCIENTIFIC ATLANTA	23, 24, 25
TOCOM	26
ZENITH	27, 28

Manufacturers' codes are subject to change without notice. If they are changed, this remote control cannot operate the equipment.

For DBS tuner

Manufacturer	Codes
JVC	56, 57, 67
AMSTRAD	43, 44, 45, 46, 47, 48, 49
BLAUPUNKT	30
ECHOSTAR	50, 51, 67
GOLDSTAR	31
GRUNDIG	32, 33
HIRSHMANN	48, 52, 53, 54, 55
INSTRUMENT	68
ITT/NOKIA	34
KATHREIN	52, 58, 59, 60, 61, 62, 63
NEC	35, 36
ORBITECH	48
PHILIPS	37, 38
RCA	65
SAMSUNG	39, 40
SCHWAIGER	61, 64
SIEMENS	41, 42
SONY	66
TECHNISAT	48

Manufacturers' codes are subject to change without notice. If they are changed, this remote control cannot operate the equipment.

To change the transmittable signals for operating another manufacturer's VCR

1. Press and hold VCR \odot/I .
2. Press VCR.
3. Enter manufacturer's code using buttons 1–9, and 0.
4. Release VCR \odot/I .

See the list to the right to find the code.

The following button can be used for operating the VCR:

VCR \odot/I : Turns on and off the VCR.

After pressing VCR, you can perform the following operations on the VCR:

CH +/-: Changes the TV channels on the VCR.
 1 – 10, 0, 100+ (+10): Selects the TV channels.
 The 10 button will function as the ENTER button if your VCR requires pressing ENTER after selecting a channel number.

PLAY▶: Starts playback.
 REW: Rewinds a video tape.
 FF: Fast winds a video tape.
 STOP■: Stops operation.
 PAUSE⏸: Pauses.
 REC PAUSE: Starts recording or enters recording pause.

Note:

Refer to the manual supplied with your VCR.

5. Try to operate your VCR by pressing VCR \odot/I .
 When your VCR turns on or off, you have entered the correct code.
If there are more than one code listed for your brand of VCR, try each one until the correct one is entered.

Manufacturer	Codes
JVC	00, 26, 27, 28, 29, 58
AIWA	01, 02
BELL & HOWELL	03
BLAUPUNKT	04, 05
CGM	06, 07
EMERSON	08, 10, 11, 12, 64, 65
FISHER	03, 14, 15, 16, 17
FUNAI	01
GE	18, 19, 20
GOLDSTAR	07
GOODMANS	13, 21
GRUNDIG	06, 22
HITACHI	18, 23, 24, 25, 66
LOEWE	07, 21
MAGNAVOX	04, 19, 24
MITSUBISHI	30, 31, 32, 33, 34, 35
NEC	26, 27
NOKIA	03, 36
NORDMENDE	38
ORION	09
PANASONIC	19, 24, 39, 40
PHILIPS	04, 19, 21, 24, 41, 42
PHONOLA	21
RCA/PROSCAN	04, 18, 19, 23, 24, 43, 44, 45
SABA	38, 46
SAMSUNG	45, 47, 59, 61, 62, 63
SANYO	03, 48, 49
SHARP	37, 50
SIEMENS	03, 51
SONY	52, 53, 54
TELEFUNKEN	55, 60
TOSHIBA	43, 44
ZENITH	56, 57

Manufacturers' codes are subject to change without notice. If they are changed, this remote control cannot operate the equipment.

To change the transmittable signals for operating another manufacturer's DVD player

1. Press and hold AUDIO $\odot/|$.
2. Press DVD.
3. Enter manufacturer's code using buttons 1-9, and 0.

See the list to the right to find the code.

4. Release AUDIO $\odot/|$.

After pressing DVD or DVD MULTI, you can perform the following operations on a DVD player:

- PLAY \blacktriangleright : Starts playing.
- ◀◀: Returns to the beginning of the current (or previous) tracks.
- ▶▶: Skips to the beginning of the next track.
- STOP \blacksquare : Stops playing.
- PAUSE II : Stops playing temporarily. To release it, press PLAY \blacktriangleright .

Manufacturer	Codes
JVC	00, 02
DENON	01
PANASONIC	03
PHILIPS	13
PIONEER	04, 05, 06
RCA	07
SAMSUNG	08
SONY	09
TOSHIBA	10
YAMAHA	11, 12

Manufacturers' codes are subject to change without notice. If they are changed, this remote control cannot operate the equipment.

After pressing DVD or DVD MULTI, these buttons can be used for the DVD menu operations.

Note:
For detailed menu operations, refer to the instructions supplied with the discs or the DVD player.

Note:
Refer to the manual supplied with your DVD player.

5. Try to operate your DVD player by pressing one of the above buttons.

- DO NOT forget to turn on the DVD player before pressing one of the above buttons.

If there are more than one code listed for your brand of DVD player, try each one until the correct one is entered.

Troubleshooting

Use this chart to help you solve daily operational problems. If there is any problem you cannot solve, contact your JVC service center.

PROBLEM	POSSIBLE CAUSE	SOLUTION
The display does not light up.	The power cord is not plugged in.	Plug the power cord into an AC outlet.
No sound from speakers.	Speaker signal cables are not connected.	Check speaker wiring and reconnect if necessary.
	The SPEAKERS ON/OFF 1 and 2 buttons are not set correctly.	Press SPEAKERS ON/OFF 1 and 2 correctly.
	An incorrect source is selected.	Select the correct source.
	Muting is activated.	Press MUTING to cancel the mute.
	An incorrect input mode (analog or digital) is selected.	Select the correct input mode (analog or digital).
	Connections are incorrect.	Check connections. For analog connections, see page 5. For digital connections, see page 8.
Sound from one speaker only.	Speaker signal cables are not connected properly.	Check speaker wiring and reconnect if necessary.
	The balance is set to one extreme.	Adjust the balance properly (see page 13).
Continuous hiss or buzzing during FM reception.	Incoming signal is too weak.	Connect an outdoor FM antenna or contact your dealer.
	The station is too far away.	Select a new station.
	An incorrect antenna is used.	Check with your dealer to be sure you have the correct antenna.
	Antennas are not connected properly.	Check connections.
Occasional cracking noise during FM reception.	Ignition noise from automobiles.	Move the antenna farther from automobile traffic.
Howling during record playing.	Your turntable is too close to speakers.	Move speakers away from the turntable.
Noise is heard.	An earth (⌚) cable is not connected to the AM (⌚) terminal on the rear panel.	Connect the cable to the AM (⌚) terminal on the rear panel.
“OVERLOAD” starts flashing on the display.	Speakers are overloaded because of high volume.	1. Press STANDBY/ON ⏻ on the front panel to turn off the receiver. 2. Stop the playback source. 3. Turn on the receiver again, and adjust the volume.
	Speakers are overloaded because of short circuit of speaker terminals.	Press STANDBY/ON ⏻ on the front panel, then check the speaker wiring. If “OVERLOAD” does not disappear, unplug the AC power cord, then plug it back again. If speaker wiring is not short-circuited, contact your dealer.
“DSP MICON NG” starts flashing on the display.	The built-in microcomputer is not functioning correctly.	Press STANDBY/ON ⏻ on the front panel to turn off the receiver. After unplugging the power cord, consult your dealer.
The STANDBY lamp lights up after turning on the power, but soon the receiver turns off (into standby mode).	The receiver is overloaded because of a high voltage.	Press STANDBY/ON ⏻ on the front panel to turn off the receiver. After unplugging the power cord, consult your dealer.
Remote control does not work.	There is an obstruction in front of the remote sensor on the receiver.	Remove the obstruction.
	Batteries are weak.	Replace batteries.
Remote control does not operate intendedly.	An incorrect remote control operation mode is selected.	Select the correct remote control operation mode. (See page 32).

Note:

When you use the digital coaxial connection, the sounds may be intermitted by the outside noise such as a lightning discharge but they will restore automatically. This is not a malfunction.

Specifications

Amplifier

Output Power

At Stereo operation:

Front channels: 100 W per channel, min. RMS, both channels driven into 8 Ω at 1 kHz with no more than 0.9% total harmonic distortion. (IEC268-3/DIN)

At Surround operation:

Front channels: 100 W per channel, min. RMS, driven into 8 Ω at 1 kHz with no more than 0.8% total harmonic distortion.

Center channel: 100 W, min. RMS, driven into 8 Ω at 1 kHz, with no more than 0.8% total harmonic distortion.

Rear channels: 100 W per channel, min. RMS, driven into 8 Ω at 1 kHz, with no more than 0.8% total harmonic distortion.

Audio

Audio Input Sensitivity/Impedance (1 kHz):

PHONO (MM): 2.7 mV/47 k Ω
CD, TAPE/CDR, TV SOUND/DBS, VCR, DVD:
220 mV/47 k Ω

Audio Input (DIGITAL IN)* :

Coaxial: DIGITAL 1 (DVD): 0.5 V(p-p)/75 Ω
Optical: DIGITAL 2 (CD), DIGITAL 3 (TV), DIGITAL 4 (CDR):
-21 dBm to -15 dBm (660 nm \pm 30 nm)
*Corresponding to Linear PCM, Dolby Digital, and DTS Digital Surround (with sampling frequency — 32 kHz, 44.1 kHz, 48 kHz).

Audio Output Level:

TAPE/CDR, VCR: 220 mV

Digital output:

Optical: DIGITAL OUTPUT
Signal wave length: 660 nm
Output level: -21 dBm to -15 dBm

Signal-to-Noise Ratio ('66 IHF/DIN):

PHONO (MM): 70 dB/66 dB (at REC OUT)
CD, TAPE/CDR, TV SOUND/DBS, VCR, DVD:
87 dB/67 dB

Frequency Response (8 Ω):

PHONO: 20 Hz to 20 kHz (\pm 1 dB)
CD, TAPE/CDR, TV SOUND/DBS, VCR, DVD:
20 Hz to 20 kHz (\pm 1 dB)

RIAA Phono Equalization: \pm 10 dB (20 Hz to 20 kHz)

Bass boost: +3 dB \pm 1.0 dB at 100 Hz

Tone Control:

Bass (100 Hz): \pm 10 dB
Treble (10 kHz): \pm 10 dB

Video

Video Input Sensitivity/Impedance:

Composite video: DBS, VCR, DVD: 1 V(p-p)/75 Ω
S-video: DBS, VCR, DVD: (Y: luminance): 1 V(p-p)/75 Ω
(C: chrominance, burst): 0.286 V(p-p)/75 Ω

Video Output Level:

Composite video: VCR, MONITOR OUT:
1 V(p-p)/75 Ω
S-video: VCR, MONITOR OUT:
(Y: luminance): 1 V(p-p)/75 Ω
(C: chrominance, burst): 0.286 V(p-p)/75 Ω

Synchronization: Negative

Signal-to-Noise Ratio: 45 dB

FM tuner (IHF)

Tuning Range: 87.50 MHz to 108.00 MHz

Usable Sensitivity: Monaural: 17.0 dBf (1.95 μ V/75 Ω)

50 dB Quieting Sensitivity:

Monaural: 21.3 dBf (3.2 μ V/75 Ω)
Stereo: 41.3 dBf (31.5 μ V/75 Ω)

Signal-to-Noise Ratio (IHF-A weighted):

Monaural: 78 dB at 85 dBf
Stereo: 73 dB at 85 dBf

Total Harmonic Distortion:

Monaural: 0.4% at 1 kHz
Stereo: 0.6% at 1 kHz

Stereo Separation at REC OUT: 35 dB at 1 kHz

Alternate Channel Selectivity: 60 dB: (\pm 400 kHz)

Frequency Response: 30 Hz to 15 kHz: (+0.5 dB, -3 dB)

AM (MW/LW) tuner

Tuning Range: MW: 522 kHz to 1 629 kHz
LW: 144 kHz to 288 kHz

Usable Sensitivity: Loop antenna: 400 μ V/m (MW)

Signal-to-Noise Ratio: 50 dB (100 mV/m)

General

Power Requirements: AC 230V \sim , 50 Hz

Power Consumption: 200 W (at operation)
2 W (in standby mode)

Dimensions (W x H x D): 435 mm x 146.5 mm x 425.5 mm
(17 ³/₁₆ in. x 5 ¹³/₁₆ in. x 16 ¹³/₁₆ in.)

Mass: 8.6 kg (19.0 lbs)

Designs & specifications are subject to change without notice.

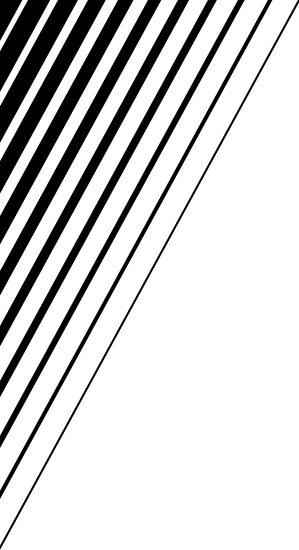

JVC
VICTOR COMPANY OF JAPAN, LIMITED